



**INSTRUMENTS**

# **GasWatch 3 for Hydrogen Sulfide Operator's Manual**

*Part Number: 71-0511*

*Revision: P3*

*Released: 12/1/21*

# **WARNING**

Read and understand this instruction manual before operating instrument. Improper use of the gas monitor could result in bodily harm or death.

Maintenance of the gas monitor is essential for proper operation and correct readings.

Bump test the instrument before each day's use with a known concentration of the target gas. A bump test can be done in User Mode's BUMP item or by applying gas in Measuring Mode. The instrument does not need to be calibrated unless it does not pass the User Mode bump test or does not respond appropriately, as defined by the user, in Measuring Mode. For more information about bump test and calibration requirements, see IEC 60079-29-2.

---

# Table of Contents

<b>Chapter 1: Introduction</b> .....	<b>6</b>
Overview .....	6
About the GasWatch 3 .....	6
Specifications .....	7
About this Manual .....	8
<b>Chapter 2: Description</b> .....	<b>9</b>
Overview .....	9
Instrument Description .....	9
<i>Case</i> .....	9
<i>LCD</i> .....	9
<i>Control Buttons</i> .....	10
<i>Alarm LEDs</i> .....	10
<i>Buzzer</i> .....	10
<i>Vibrator</i> .....	10
<i>Sensor</i> .....	10
<i>Filters</i> .....	11
<i>Infrared Communications Port</i> .....	11
<i>Battery</i> .....	11
Standard Accessories .....	12
<i>Alligator Clip</i> .....	12
Optional Accessories .....	12
<i>Watch Band</i> .....	12
<i>Calibration Cup</i> .....	13
<i>IrDA/USB Cable</i> .....	13
<b>Chapter 3: Measuring Mode</b> .....	<b>14</b>
Overview .....	14
Start Up .....	14
<i>Turning On the GasWatch 3</i> .....	14
<i>Performing a Demand Zero</i> .....	19
<i>Turning Off the GasWatch 3</i> .....	19
Measuring Mode Operation .....	19
<i>Monitoring an Area</i> .....	20
Alarms .....	21
<i>Alarm Indications</i> .....	21
<i>Responding to Alarms</i> .....	23
Data Logging .....	25
<b>Chapter 4: Display Mode</b> .....	<b>27</b>
Tips for Using Display Mode .....	27
Peak Screen (PEAK) .....	28
STEL Screen (STEL) .....	28
TWA Screen (TWA) .....	29

User ID Screen (USER ID).....	29
Station ID Screen (STN ID).....	30
Last Successful Calibration Date (CAL.DATA).....	31
Last Successful Bump Test Screen (BP.DATA).....	31
Date/Time Screen (DATE).....	32
Temperature Screen (TEMP).....	32
Alarm Points Screen (ALARM--P).....	32
Adjusting the Buzzer Volume (BUZZ.VOL).....	33

**Chapter 5: User Mode and Calibration..... 34**

Overview.....	34
Entering User Mode.....	37
Tips for Using User Mode.....	38
Performing a Bump Test (BUMP).....	38
Performing a Calibration (GAS CAL).....	43
Setting Calibration Parameters (CAL SET).....	52
Setting Bump Test Parameters (BUMP.SET).....	54
Alarm Settings (ALARM--P).....	58
Updating the Lunch Break Setting (LUNCH).....	60
Setting the Confirmation Beep and Non-Compliance Indicator (BEEP).....	61
Updating the Backlight Time (BL TIME).....	62
Turning the Key Tone On/Off (KEY.TONE).....	63
Display Mode Items (DISP.SET).....	63
Zero Suppression (ZERO.SUP).....	63
Zero Follower (ZERO.FLW).....	64
Turning Easy Calibration On/Off (E-CAL).....	64
Setting the Date/Time (DATE).....	64
Turning the Password On/Off (PASS-W).....	65
Viewing the ROM/SUM (ROM/SUM).....	66
Entering Measuring Mode (START).....	66

**Chapter 6: Maintenance ..... 67**

Overview.....	67
Troubleshooting.....	67
Replacing the Battery.....	68
Replacing the Humidity Filter.....	69
Replacing the Hydrophobic Filter.....	70
Replacing the Sensor.....	72

**Chapter 7: General Parts List ..... 73**

**Appendix A: Maintenance Mode ..... 75**

Overview.....	75
Entering Maintenance Mode.....	76
Tips for Using Maintenance Mode.....	77
Performing a Calibration (GAS CAL).....	78
Performing a Gas Test (GAS.TEST).....	78
Sensor/Battery Replacement Date (SEN.DATE).....	79

Performing a Bump Test (BUMP) .....	80
Setting Alarms to Latching or Self-Resetting (LATCH) .....	80
Turning the Demand Zero Function On/Off (D.ZERO).....	81
Turning the Auto Zero Function On/Off (A.ZERO).....	81
Turning the ID Display Function On/Off (ID DISP) .....	82
Turning the Zero Suppression On/Off (ZERO.SUP) .....	82
Turning the Zero Follower On/Off (ZERO.FLW) .....	82
User Mode Zero Suppression (ZSUP.DSP) .....	82
User Mode Zero Follower (ZFLW.DSP) .....	82
Cylinder Setting (CYL.DISP).....	83
Setting the Date/Time (DATE) .....	83
Turning the Password On/Off (PASS-W).....	83
Viewing the ROM/SUM (ROM/SUM).....	84
Performing a Default (M.DEF).....	85
Entering Measuring Mode (START) .....	85

**Appendix B: Gas Select Mode ..... 86**

Overview.....	86
Entering Gas Select Mode .....	86
Tips for Using Gas Select Mode.....	87
Saving the Alarm Points (SAVE-AP) .....	87
Turning the Calibration Max Span On/Off (MAX.SPAN).....	88
Stealth and Vibrator Settings (STEALTH) .....	89
Exiting Gas Select Mode (START).....	89

**Warranty ..... 90**

---

**WARNING:** *Understand manual before operating. This is an intrinsically safe product. Substitution of components may impair intrinsic safety. To prevent ignition of a hazardous atmosphere, batteries must only be changed or charged in an area known to be nonhazardous. Not tested in oxygen enriched atmospheres (above 21%).*

---



---

**AVERTISSEMENT:** *Comprendre le manuel avant de l'utiliser. Ceci est un produit intrinsèquement sûr. La substitution de composants peut nuire à la sécurité intrinsèque. Pour éviter l'inflammation d'une atmosphère dangereuse, les batteries ne doivent être remplacées ou chargées que dans une zone non dangereuse. Non testé dans des atmosphères enrichies en oxygène (plus de 21%).*

---

# Chapter 1: Introduction

---

## Overview

This chapter briefly describes the GasWatch 3 gas monitor. This chapter also describes the *GasWatch 3 Operator's Manual* (this document). Table 1 at the end of this chapter lists the specifications for the GasWatch 3.

---

## About the GasWatch 3

Using an advanced detection system, the GasWatch 3 personal gas monitor detects the presence of hydrogen sulfide (H<sub>2</sub>S). The GasWatch 3's compact size and easy-to-use design make it ideally suited for a wide range of applications, including sewage treatment plants, utility manholes, tunnels, hazardous waste sites, power stations, petrochemical refineries, mines, paper mills, drilling rigs, and fire fighting stations. The GasWatch 3 offers a full range of features, including:

- Liquid crystal display (LCD) for complete and understandable information at a glance
- Ultrabright alarm LEDs
- Distinctive audible/vibrating alarms for dangerous gas conditions and audible alarms for unit malfunction
- Microprocessor control for reliability, ease of use, and advanced capabilities
- Data logging functions
- Alarm trend data
- STEL, TWA, and over range alarms
- Peak reading
- Built-in time function
- Lunch break feature
- CSA "C/US" classification for Class I, Division I, Groups A, B, C, and D hazardous atmospheres

---

**WARNING:** *The Model GasWatch 3 detects elevated levels of hydrogen sulfide which can be dangerous or life threatening. When using the GasWatch 3, you must follow the instructions and warnings in this manual to assure proper and safe operation of the unit and to minimize the risk of personal injury. Be sure to maintain and periodically calibrate the GasWatch 3 as described in this manual.*

---

---

**AVERTISSEMENT:** *Le modèle GasWatch 3 détecte les niveaux élevés de sulfure d'hydrogène qui peuvent être dangereux ou mettre la vie en danger. Lorsque vous utilisez le GasWatch 3, vous devez suivre les instructions et les avertissements de ce manuel pour assurer un fonctionnement correct et en toute sécurité de l'appareil et pour réduire les risques de blessures. Assurez-vous de maintenir et d'étalonner périodiquement le GasWatch 3 comme décrit dans ce manuel.*

---

# Specifications

**Table 1: Standard Sensor Specifications/Alarm Points**

<b>Detection Range</b>	0 - 200 ppm
<b>Lowest Detectable Limit (LDL)</b>	0.5 ppm
<b>Reading Increment</b>	0 - 30.0 ppm: 0.1 ppm 31 - 200 ppm: 1 ppm
<b>Warning Factory Setting</b>	5.0 ppm
<b>Alarm Factory Setting</b>	30.0 ppm
<b>Alarm H Factory Setting</b>	100 ppm
<b>STEL Alarm</b>	5.0 ppm
<b>TWA Alarm</b>	1.0 ppm
<b>Indication Accuracy</b>	<ul style="list-style-type: none"> <li>• 0 - 100 ppm: <math>\pm 5\%</math> of reading or <math>\pm 2</math> ppm H<sub>2</sub>S (whichever is greater)</li> <li>• 101 - 200 ppm: <math>\pm 20\%</math> of reading</li> </ul>

**Table 2: GasWatch 3 Specifications**

<b>Sampling Method</b>	Diffusion
<b>Response Time</b>	T90 Within 10 Seconds
<b>Display</b>	Graphics LCD Display
<b>Operating Temperature &amp; Humidity</b>	<b>Continuous environment:</b> -20°C to 50°C/10 to 90% RH <b>Temporary environment (up to 15 minutes):</b> -20°C to 60°C/0 to 95% RH
<b>Safety/Regulatory</b>	<ul style="list-style-type: none"> <li>• ATEX: II 1G Ex ia IIC T4 Ga Certificate Number Presafe DEKRA 18ATEX0130</li> <li>• IECEx: Ex ia IIC T4 Ga Certificate Number IECEx DEK 18.0082</li> <li>• CSA classified, "C/US", as Intrinsically Safe. Exia. Class I, Groups A, B, C, &amp; D. Temperature Code T3A. Certificate Number CSA 19 CA70213062</li> </ul> <div style="text-align: center;">             C US            186718         </div>
<b>Power Supply</b>	CR2450 button cell battery
<b>Continuous Operating Hours @ 25 °C</b>	4,000 hours in Measuring Mode (Non Alarm Operation, Fully Charged)

<b>Case</b>	High-impact Plastic, RF Shielded, Dust and Weather Proof (IP66/68)
<b>Standard Accessories</b>	<ul style="list-style-type: none"> <li>• Alligator clip</li> </ul>
<b>Optional Accessories</b>	<ul style="list-style-type: none"> <li>• Watch band</li> <li>• Calibration cup</li> <li>• Datalogging and Setup Programs (Windows® 7, 8, and 10), available at <a href="http://www.rkiinstruments.com/gw3">www.rkiinstruments.com/gw3</a></li> <li>• IrDA/USB Cable for connecting to a computer when using the Datalogging and Setup Programs (not needed if computer has an infrared port)</li> </ul>
<b>Dimensions and Weight</b>	<p>Approximately 42(H) x 63(W) x 22(D) mm (1.7"H x 2.5"W x 0.9"D)</p> <p>Approximately 45 g (1.6 oz.)</p>

---

## About this Manual

The *GasWatch 3 Operator's Manual* uses the following conventions for notes, cautions, and warnings.

---

**NOTE:** Describes additional or critical information.

---



---

**CAUTION:** Describes potential damage to equipment.

---



---

**WARNING:** Describes potential danger that can result in injury or death.

---



# Chapter 2: Description

---

## Overview

This chapter describes the GasWatch 3 instrument and its accessories.

---

## Instrument Description

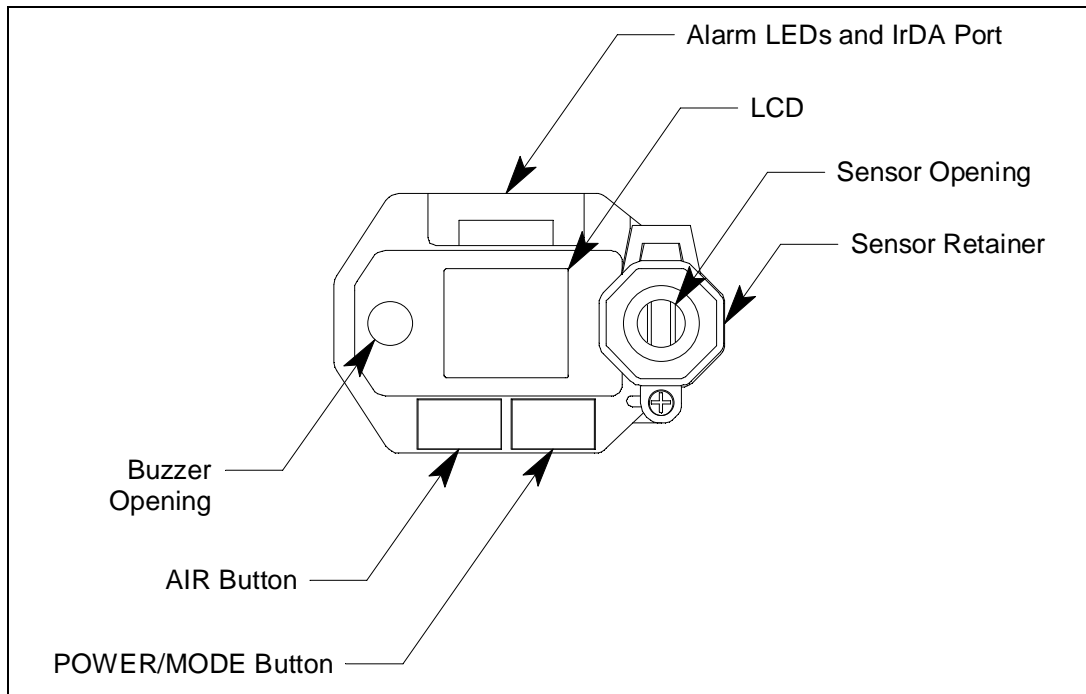

**Figure 1: Component Location**

### Case

The GasWatch 3's sturdy, high-impact plastic case is radio frequency (RF) resistant and is suitable for use in many environmental conditions, indoors and out. The case is dust proof and water resistant. A clear plastic window is located on the front of the case for viewing the LCD. The sensor retainer is located on the right side of the case and allows access to the filters and sensor.

### LCD

A digital LCD (liquid crystal display) is visible through a clear plastic window in the top case. The LCD shows the gas reading. The LCD also shows information for each of the GasWatch 3's operating modes.

## Control Buttons

Two control buttons, AIR and POWER/MODE, are located below the LCD.

**Table 3: GasWatch 3 Control Button Functions**

Button	Function(s)
AIR	<ul style="list-style-type: none"><li>• turns on LCD backlight</li><li>• resets alarm condition if <b>LATCH</b> is set to <b>ON</b> in Maintenance Mode</li><li>• enters User Mode, Maintenance Mode, and Gas Select Mode when used with POWER/MODE</li><li>• activates the demand zero function (adjusts the GasWatch 3's fresh air reading)</li><li>• changes the value of a parameter available for adjustment</li><li>• scrolls through parameter options</li></ul>
POWER/MODE	<ul style="list-style-type: none"><li>• turns the GasWatch 3 on and off</li><li>• turns on LCD backlight</li><li>• enters and scrolls through Display Mode</li><li>• enters instructions into the GasWatch 3's microprocessor</li><li>• resets alarm condition if <b>LATCH</b> is set to <b>ON</b> in Maintenance Mode</li><li>• enters User Mode, Maintenance Mode, and Gas Select Mode when used with AIR</li></ul>

## Alarm LEDs

The two alarm LEDs above the LCD alert you to gas, low battery, and failure alarms.

## Buzzer

One solid-state electronic buzzer is located inside the case. Sound exits the case through a hole in the middle front of the case. The buzzer sounds for gas alarms, malfunctions, and low battery voltage. It also provides feedback for button presses and while in Display, User, Maintenance, or Gas Select Mode.

## Vibrator

A vibrating motor inside the GasWatch 3 case vibrates for gas alarms and unit malfunctions.

---

**NOTE:** If **STEALTH** is set to **ON**, the vibrator only functions when **VIB** in the **STEALTH** Gas Select Mode item is set to **ON** (see pg.89).

---

## Sensor

The sensor retainer holds the sensor in its socket. The H<sub>2</sub>S sensor is an electrochemical cell that consists of two precious metal electrodes in a dilute acid electrolyte. A gas permeable membrane covers the sensor face and allows gas to diffuse into the electrolyte. The gas reacts in the sensor and produces a current proportional to the concentration of the target gas. The GasWatch 3's circuitry amplifies the current, converts the current to a gas concentration, and displays the concentration on the LCD.

## Filters

### ***Humidity Filter (White)***

A white humidity filter covers the H<sub>2</sub>S sensor. The filter absorbs humidity in the sampling environment to prevent unstable readings around 0 ppm H<sub>2</sub>S. For users with a 1 ppm H<sub>2</sub>S alarm setpoint, the filter should be replaced every 6 months, if you notice a drift on the zero reading, or if the filter appears dirty (whichever is sooner). For users with a 2 ppm or higher H<sub>2</sub>S setpoint, the filter does not necessarily need to be replaced.

### ***Hydrophobic Filter***

The white, circular hydrophobic filter sits on the filter gasket, covering the sensor port and the humidity filter.

## Infrared Communications Port

An infrared (IR) communications port is located at the top of the instrument, near the LEDs. Logged data transmits through the port in standard IrDA protocol. A computer's infrared port or an IrDA/USB cable connected to a USB port can be used to download data to the GasWatch 3 Datalogging Program. See the GasWatch 3 Datalogging Program operator's manual for data logging and downloading instructions.

## Battery

A user-replaceable CR2450 button cell battery powers the GasWatch 3. At 25°C the battery lasts at least 4,000 hours (166 days). The battery icon in the upper right of the LCD shows remaining battery life.

A low battery warning activates when the GasWatch 3 detects a low battery voltage. The GasWatch 3 sounds a dead battery alarm when battery voltage is too low for Measuring Mode.

---

**NOTE:** Use of batteries not specified by RKI Instruments, Inc. compromises the CSA classification and may void the warranty. See "Replacing the Battery" on page 68.

---

---

**WARNING:** *To prevent ignition of a hazardous atmosphere, the battery must only be changed in an area known to be nonhazardous.*

---

---

**AVERTISSEMENT:** *Pour éviter l'inflammation d'une atmosphère dangereuse, la batterie ne doit être remplacée que dans une zone non dangereuse.*

---

---

## Standard Accessories

### Alligator Clip

An alligator clip is installed to a base clip that attaches to spring bars on the back of the GasWatch 3. Use the alligator clip to attach the GasWatch 3 to clothing or a belt. Teeth in the alligator clip's jaws prevent slipping. The alligator clip can be rotated to change the instrument's orientation.

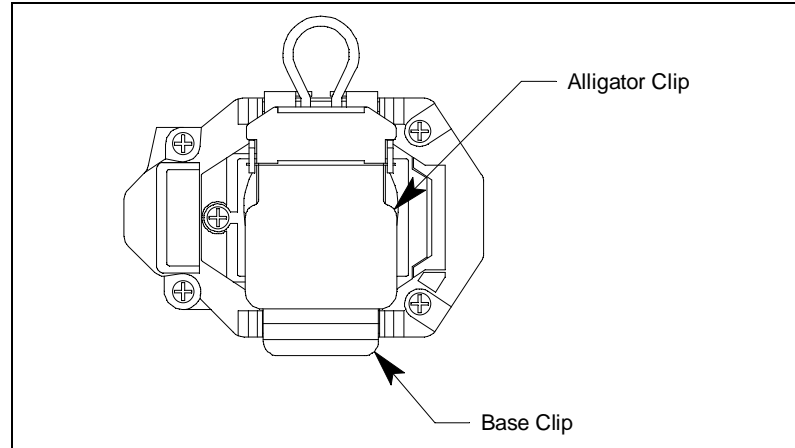

**Figure 2: Alligator Clip**

---

## Optional Accessories

### Watch Band

The adjustable watch band allows the GasWatch 3 to be worn on the wrist. The watch band attaches to spring bars that are protected by hollow tubes.

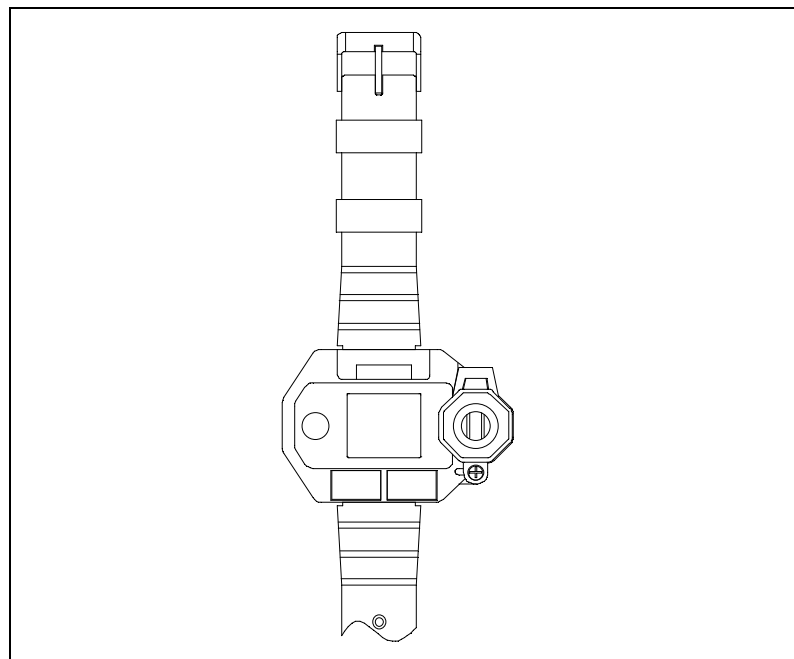

**Figure 3: Watch Band**

## Calibration Cup

The calibration cup installs over the sensor. You must use the calibration cup when performing a bump test, calibration, or gas test.

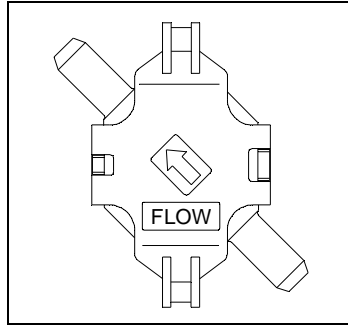

**Figure 4: Calibration Cup**

## IrDA/USB Cable

Unless your computer has a built-in IrDA port, a IrDA/USB cable is needed to establish communication between the GasWatch 3 and the Datalogging Program or the Setup Program.

# Chapter 3: Measuring Mode

## Overview

This chapter explains how to use the GasWatch 3 to perform confined space entry monitoring or general area monitoring in Measuring Mode.

## Start Up

This section explains how to start up the GasWatch 3, get it ready for operation, and turn it off.

### Turning On the GasWatch 3

To illustrate certain functions, the following description of the GasWatch 3 start up sequence assumes that the following items in User Mode are turned on: **LUNCH**, **CAL.RMDR**, and **BP.RMDR** in User Mode, and **ID DISP** and **A.ZERO** in Maintenance Mode. If any of these items are turned off, then the corresponding screens do not appear.

1. Press and briefly hold down POWER/MODE. Release the button when you hear a beep.
2. If **LUNCH** is set to **ON** (factory setting if **OFF**, see pg.60), the Lunch Break Screen appears. The unit counts down from 5 seconds.

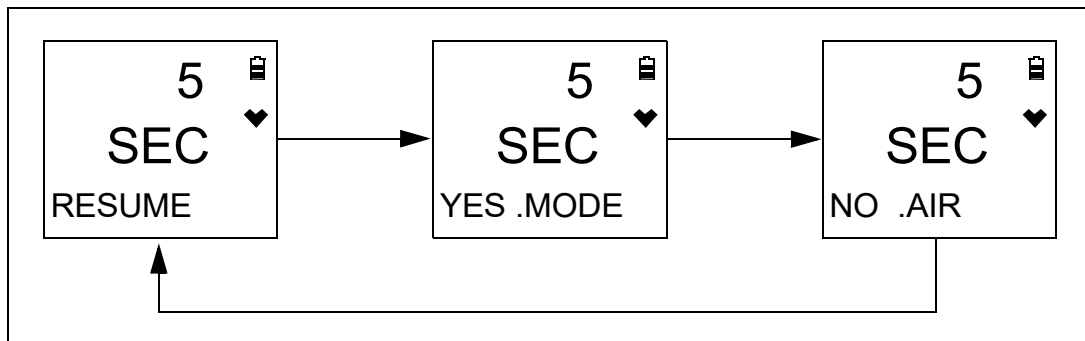

- a. Continue Accumulating: To continue accumulating peak and time-weighted average (TWA) readings from the last time the GasWatch 3 was used, press and release POWER/MODE or allow the countdown to reach 0. The short-term exposure limit (STEL) reading is reset each time the GasWatch 3 is turned on.
- b. Reset Accumulation: To reset the accumulation of peak and time-weighted average (TWA) readings, press and release AIR before the countdown reaches 0.

3. If **CAL.RMDR** is set to **ON** (factory setting) and a calibration is due, the screen that appears next depends on how **CAL.EXPD** is set in User Mode (see pg.53). The three possible screens are described below. If a calibration is not due, the instrument displays the number of days left until a calibration is due.

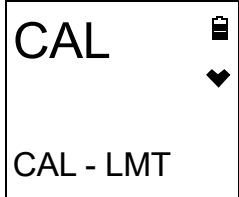
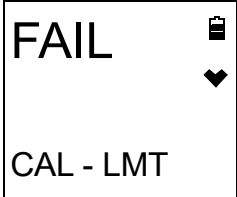
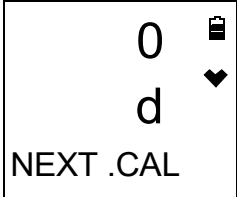
	<b>CAL.EXPD</b> set to <b>CONFIRM</b> (factory setting)	<b>CAL.EXPD</b> set to <b>CANT.USE</b>	<b>CAL.EXPD</b> set to <b>NONE</b>
<b>LCD</b>			
<b>Sound</b>	Buzzer sounds double pulsing tone	Buzzer sounds double pulsing tone	None
<b>Action</b>	<ul style="list-style-type: none"> <li>• <u>Option A, Perform calibration:</u> Press and release POWER/MODE to enter User Mode and perform a calibration. The instrument takes you straight to the calibration start screen in User Mode's GAS CAL/A-CAL(E-CAL) item. See pg.43 for calibration instructions.</li> </ul> <p><i>NOTE: If Password Protection is set ton <b>On</b> (factory setting is <b>Off</b>) using the GW-3 Config Program, you will be prompted for a password to enter User Mode.</i></p> <p>If the calibration is successful, the screen above will not appear again until the unit is due for calibration. If the calibration is not successful, the screen above will again appear in the startup sequence.</p> <ul style="list-style-type: none"> <li>• <u>Option B, Bypass message:</u> To continue without performing a calibration, press and release AIR.</li> </ul>	<p>The GasWatch 3 cannot be used until a successful calibration is performed. Press and release POWER/MODE to enter User Mode and perform a calibration. The instrument takes you straight to the calibration start screen in User Mode's GAS CAL/A-CAL (E-CAL) item. If you don't press POWER/MODE, the instrument automatically goes to the calibration start screen after 6 seconds. See pg.43 for calibration instructions.</p> <p><i>NOTE: If Password Protection is set ton <b>On</b> (factory setting is <b>Off</b>) using the GW-3 Config Program, you will be prompted for a password to enter User Mode.</i></p> <p>If the calibration is successful, the screen above will not appear again until the unit is due for calibration. If the calibration is not successful, the screen above will again appear in the startup sequence.</p>	<ul style="list-style-type: none"> <li>• <u>Option A, Perform calibration:</u> If you want to enter User Mode and perform a calibration, press and release POWER/MODE. The instrument takes you straight to the calibration start screen in User Mode's GAS CAL/A-CAL (E-CAL) item.</li> <li>• <u>Option B, Bypass message:</u> To continue without performing a calibration, wait a few seconds for the instrument to continue with its startup sequence.</li> </ul>

4. If **BP.RMDR** is set to **ON** (factory setting is **OFF**) and a bump test is due, the screen that appears next depends on how **BP.EXPD** is set in User Mode (see pg.57). The three possible screens are described below. If a bump test is not due, the instrument displays the number of days left until a bump test is due.

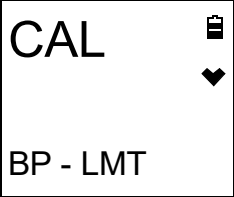
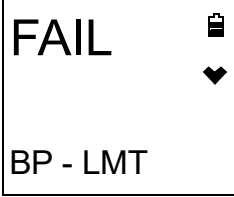
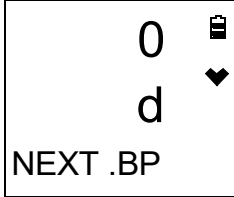
	<b>BP.EXPD</b> set to <b>CONFIRM</b> (factory setting)	<b>BP.EXPD</b> set to <b>CANT.USE</b>	<b>BP.EXPD</b> set to <b>NONE</b>
<b>LCD</b>			
<b>Sound</b>	Buzzer sounds double pulsing tone	Buzzer sounds double pulsing tone	None
<b>Action</b>	<ul style="list-style-type: none"> <li>• <u>Option A, Perform bump test:</u> Press and release <b>POWER/MODE</b> to enter User Mode and perform a bump test. The instrument takes you straight to the bump test start screen in User Mode's <b>BUMP</b> item. See pg.38 for bump test instructions.</li> </ul> <p><b>NOTE:</b> <i>If Password Protection is set to <b>On</b> (factory setting is <b>Off</b>) using the <b>GW-3 Config Program</b>, you will be prompted for a password to enter User Mode.</i></p> <p>If the bump test is successful, the screen above will not appear again until the unit is due for bump testing. If the bump test is not successful, the screen above will appear in the startup sequence.</p> <ul style="list-style-type: none"> <li>• <u>Option B, Bypass message:</u> To continue without performing a bump test, press and release <b>AIR</b>.</li> </ul>	<p>The GasWatch 3 cannot be used until a successful bump test is performed. Press and release <b>POWER/MODE</b> to enter User Mode and perform a bump test. The instrument takes you straight to the bump test start screen in User Mode's <b>BUMP</b> item. If you don't press <b>POWER/MODE</b>, the instrument automatically goes to the bump test start screen after 6 seconds. See pg.38 for bump test instructions.</p> <p><b>NOTE:</b> <i>If Password Protection is set to <b>On</b> (factory setting is <b>Off</b>) using the <b>GW-3 Config Program</b>, you will be prompted for a password to enter User Mode.</i></p> <p>If the bump test is successful, the screen above will not appear again until the unit is due for bump testing. If the bump test is not successful, the screen above will appear in the startup sequence.</p>	<ul style="list-style-type: none"> <li>• <u>Option A, Perform bump test:</u> If you want to enter User Mode and perform a bump test, press and release <b>POWER/MODE</b>. The instrument takes you straight to the bump test start screen in User Mode's <b>BUMP</b> item.</li> <li>• <u>Option B, Bypass message:</u> To continue without performing a bump test, wait a few seconds for the instrument to continue with its startup sequence.</li> </ul>

5. The Date/Time Screen appears for a few seconds.

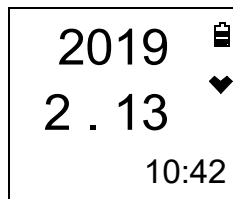



- The Battery Voltage Screen appears for a few seconds. An “AL-L” at the bottom of the screen indicates that the alarms are set to latching. An “AL-A” at the bottom of the screen indicates that the alarms are set to auto reset. See pg.80 for a description of how to change this parameter.

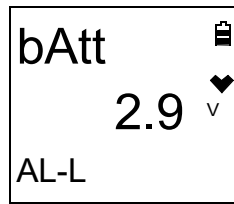

- The following screens display for 1 second each: Gas Name, Full Scale, Warning Setpoint, Alarm Setpoint, Alarm H Setpoint, STEL Setpoint, and TWA Setpoint.

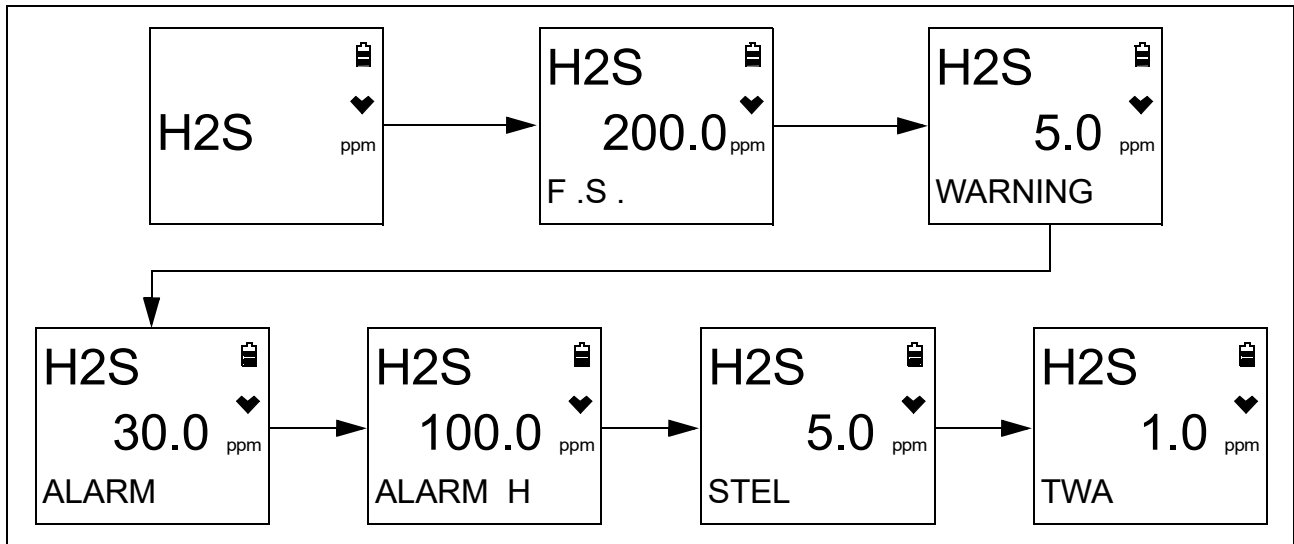

- If **ID DISP** is set to **ON** (factory setting is **OFF**, see pg.82), the User ID Screen appears for a few seconds, followed by the Station ID Screen.

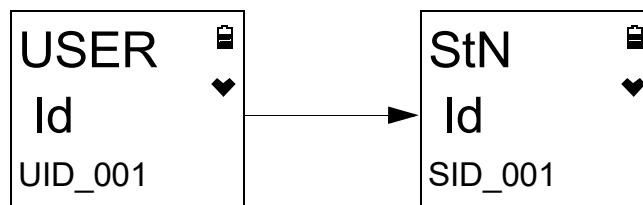

- If the GasWatch 3 experiences a sensor failure during start up, a screen indicating that the sensor failed appears and the buzzer sounds a double pulsing tone once per second.

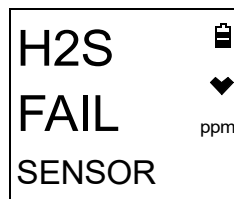

You cannot acknowledge the failure and continue to Measuring Mode. Replace the failed sensor as soon as possible.

10. If **A.ZERO** is set to **ON** (factory setting is **OFF**, see pg.81), the instrument prompts you to do an auto zero. An auto zero operation sets the reading to 0 ppm.

---

**WARNING:** *Make sure that the instrument is in a known fresh air environment (an environment free of combustibile or toxic gases and of normal oxygen content, 20.9%) before performing an auto zero operation. If you perform an auto zero operation in an area with gases present, the adjustment will not be accurate.*

---

You must press and release the POWER/MODE button to perform an auto zero function. If you do not press any key, after 15 seconds, the instrument enters Measuring Mode without performing an auto zero.

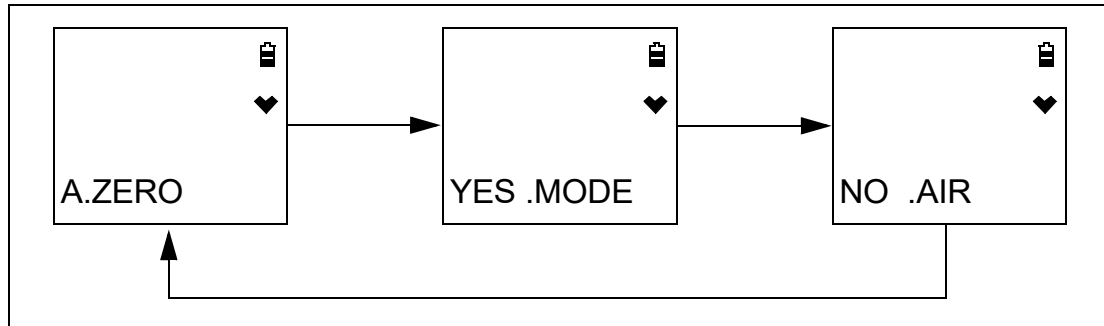

If **Password Protection** is turned **On** (factory setting is **Off**) using the GW-3 Setup Program, a user-set password is required to perform an auto zero. When the password screen appears, adjust each digit with the AIR button and press and release the POWER/MODE button to move on to the next digit. Once the password is entered, the instrument performs the auto zero.

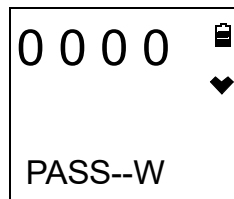

11. The GasWatch 3 is now monitoring for gas in Measuring Mode. The Measuring Mode Screen displays the current gas reading.

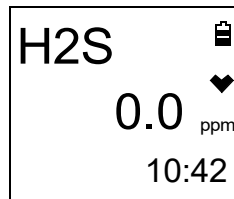

## Performing a Demand Zero

Perform a demand zero before using the GasWatch 3. This sets the reading to 0 ppm.

1. Find a fresh-air environment. This is an environment free of toxic or combustible gases and of normal oxygen content (20.9%).
2. Turn on the unit as described above in “Turning On the GasWatch 3”.
3. Press and hold AIR. The buzzer pulses and the LCD prompts you to continue holding AIR (if **KEY.TONE** is set to **ON** in User Mode).
4. Continue to hold AIR until the LCD prompts you to release it. The GasWatch 3 sets the fresh air reading. Start up is complete and the unit is now ready for monitoring.
5. If **Password Protection** is turned **On** (factory setting is **Off**) using the GW-3 Setup Program, a user-set password is required to perform a demand zero. When the password screen appears, adjust each digit with the AIR button and press and release the POWER/MODE button to move on to the next digit. Once the password is entered, the instrument performs the demand zero.

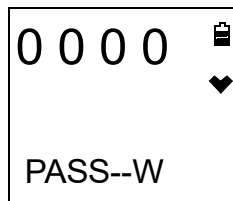

## Turning Off the GasWatch 3

1. Press and hold POWER/MODE.
2. OFF appears on the display and the buzzer pulses for about five seconds (if **KEY.TONE** is set to **ON** in User Mode).
3. Release the button when OFF disappears from the display.

If **Password Protection** is turned **On** (factory setting is **Off**) using the GW-3 Setup Program, a user-set password is required to turn off the GasWatch 3. When the password screen appears, adjust each digit with the AIR button and press and release the POWER/MODE button to move on to the next digit. Once the password is entered, the instrument turns off.

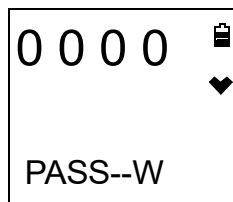

---

## Measuring Mode Operation

When the GasWatch 3 completes its startup sequence, it is in Measuring Mode. In Measuring Mode the GasWatch 3 continuously monitors the sampled atmosphere and displays the gas

concentration. The GasWatch 3 is in Normal Operation if there are no alarm indications.

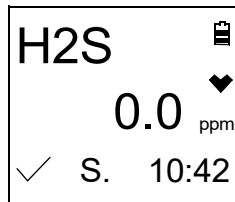

Heart Symbol: The heart symbol on the right side of the LCD indicates the operation status and flashes when normal. A microprocessor error causes the heart symbol to stop flashing or to disappear.

Check Mark: If **BP.RMDR** is set to **ON** and if a bump test is not due, a check mark appears in the lower left corner of the LCD.

“S”: If the instrument is operating in Stealth Mode, an “S.” appears at the bottom of the LCD.

Backlight: In a low-light environment, press and release either button to turn on the display backlight. See pg.62 to program backlight duration.

Confirmation/Non-Compliance Indicator: If the **BEEP** item in User Mode is set to anything other than **OFF**, the GasWatch 3 gives periodic indications to confirm that it's operating or to indicate a non-compliance (see pg.61).

## Monitoring an Area

1. Start up the GasWatch 3 as described above in “Start Up” on page 14. It is now in Measuring Mode.

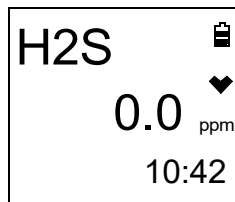

2. Take the GasWatch 3 to the monitoring area.
3. Wait at least 15 seconds.

4. If a reading is observed, allow the reading to stabilize to determine the gas concentration present.
5. If a gas alarm occurs, take appropriate action. See pg.23.

---

## Alarms

This section covers alarm indications in Measuring Mode. It also describes how to reset the GasWatch 3 after an alarm occurs and how to respond to an alarm condition.

---

**NOTE:** False alarms may be caused by radio frequency (RF) or electromagnetic (EMI) interference. Keep the GasWatch 3 away from RF and EMI sources such as radio transmitters or large motors.

---

### Alarm Indications

The GasWatch 3 buzzer sounds an alarm, the LEDs flash, and the vibrator pulses when any sort of alarm condition or failure occurs. If the GasWatch 3 is operating in Stealth Mode, the buzzer does not sound and the vibrator's operation depends on the **VIB** setting in Gas Select Mode's **STEALTH** item. See pg.89 for more information.

---

**NOTE:** If an alarm condition occurs while you are in Display Mode, the GasWatch 3 automatically returns to the Measuring Mode screen.

---

The table below summarizes the types of alarms produced by the GasWatch 3 and their indications.

**Table 4: Alarm Types and Indications**

Alarm Type	Visual Indications	Other Indications
<p><b>Warning</b></p> <p>Concentration of gas rises above the Warning setting.</p>	<ul style="list-style-type: none"> <li>• Gas reading flashes</li> <li>• <b>WARNING</b> appears at the bottom of the LCD</li> <li>• Alarm LEDs flash once per second</li> <li>• Backlight turns on</li> </ul>	<ul style="list-style-type: none"> <li>• High-low tone sounds once per second</li> <li>• Vibrator pulses once per second</li> </ul>
<p><b>Alarm</b></p> <p>Concentration of gas rises above the Alarm setting.</p>	<ul style="list-style-type: none"> <li>• Gas reading flashes</li> <li>• <b>ALARM</b> appears at the bottom of the LCD</li> <li>• Alarm LEDs flash twice per second</li> <li>• Backlight turns on</li> </ul>	<ul style="list-style-type: none"> <li>• High-low tone sounds twice per second</li> <li>• Vibrator pulses twice per second</li> </ul>
<p><b>Alarm H</b></p> <p>Concentration of gas rises above the Alarm H setting.</p>	<ul style="list-style-type: none"> <li>• Gas reading flashes</li> <li>• <b>ALARM H</b> appears at the bottom of the LCD</li> <li>• Alarm LEDs flash twice per second</li> <li>• Backlight turns on</li> </ul>	<ul style="list-style-type: none"> <li>• High-low tone sounds twice per second</li> <li>• Vibrator pulses twice per second</li> </ul>

**Table 4: Alarm Types and Indications**

Alarm Type	Visual Indications	Other Indications
<p><b>TWA or STEL</b> Concentration rises above the TWA or STEL alarm setting.</p>	<ul style="list-style-type: none"> <li>• Gas reading flashes</li> <li>• <b>TWA or STEL</b> appears at the bottom of the LCD</li> <li>• Alarm LEDs flash once per second</li> <li>• Backlight turns on</li> </ul>	<ul style="list-style-type: none"> <li>• High-low tone sounds once per second</li> <li>• Vibrator pulses once per second</li> </ul>
<p><b>Over Range</b></p>	<ul style="list-style-type: none"> <li>• Gas reading is replaced with a flashing □□□</li> <li>• Gas name and units flash</li> <li>• <b>OVER</b> appears at the bottom of the LCD</li> <li>• Alarm LEDs flash twice per second</li> <li>• Backlight turns on</li> </ul>	<ul style="list-style-type: none"> <li>• High-low tone sounds twice per second</li> <li>• Vibrator pulses twice per second</li> </ul>
<p><b>Minus Over Range</b></p>	<ul style="list-style-type: none"> <li>• Affected channel's gas reading is replaced with a flashing □□□</li> <li>• Gas name and units flash</li> <li>• <b>M OVER</b> appears at the bottom of the LCD</li> <li>• Alarm LEDs flash twice per second</li> <li>• Backlight turns on</li> </ul>	<ul style="list-style-type: none"> <li>• High-low tone sounds twice per second</li> <li>• Vibrator pulses twice per second</li> </ul>
<p><b>Low Battery Warning</b></p>	<ul style="list-style-type: none"> <li>• The last bar in the battery icon disappears and the battery icon starts flashing</li> </ul>	<p>None</p>
<p><b>Dead Battery Alarm</b></p>	<ul style="list-style-type: none"> <li>• Gas reading disappears. <b>FAIL BATTERY</b> appears on the LCD.</li> <li>• Alarm LEDs flash once per second</li> </ul>	<p>Double pulsing tone sounds once per second</p>
<p><b>Sensor Failure</b></p>	<ul style="list-style-type: none"> <li>• <b>FAIL SENSOR</b> appears on the LCD.</li> <li>• Alarm LEDs flash once per second</li> </ul>	<p>Double pulsing tone sounds once per second</p>
<p><b>Clock Failure</b></p>	<ul style="list-style-type: none"> <li>• <b>FAIL 050 CLOCK</b> appears on the LCD</li> <li>• Alarm LEDs flash once per second</li> </ul>	<p>Double pulsing tone sounds once per second</p>
<p><b>System Failure</b></p>	<ul style="list-style-type: none"> <li>• <b>FAIL SYSTEM</b> and an error code appear on the LCD</li> <li>• Alarm LEDs flash once per second</li> </ul>	<p>Double pulsing tone sounds once per second</p>

## Responding to Alarms

This section describes response to gas, over range, battery, sensor failure, clock failure, and system failure alarms.

### Responding to Gas Alarms

1. Follow your established procedure for an increasing gas condition.
2. Reset the alarm as necessary or allowed.
  - a. If **LATCH** is set to **ON** (factory setting) in Maintenance Mode, the gas reading must fall below an alarm setting before you can reset the alarm condition using **POWER/MODE** or **AIR**.

If **Password Protection** is set to **On** using the GW-3 Config Program, you must press **AIR** and **POWER/MODE** at the same time and then enter a user-set password to reset the gas alarm.

- b. If **LATCH** is set to **OFF** in Maintenance Mode, the alarm condition automatically resets when gas reading falls below an alarm setpoint.

### Responding to Over Range Alarms

---

**WARNING:** *An over range condition may indicate an extreme hydrogen sulfide concentration. Confirm the gas concentration with a different GasWatch 3 or with another gas detecting device.*

---

---

**AVERTISSEMENT:** *Un dépassement de la plage peut indiquer une concentration extrême en sulfure d'hydrogène. Confirmez la concentration de gaz avec un GasWatch 3 différent ou avec un autre dispositif de détection de gaz.*

---

1. Follow your established procedure for an extreme gas condition.
2. Reset the alarm using **POWER/MODE** or **AIR** once the alarm condition clears if **LATCH** is set to **ON** (factory setting) in Maintenance Mode.

If **Password Protection** is set to **On** using the GW-3 Config Program, you must press **AIR** and **POWER/MODE** at the same time and then enter a user-set password to reset the over range alarm.

3. Calibrate the GasWatch 3 as described on pg.43.
4. If the over range condition continues or if you are not able to successfully calibrate the unit, you may need to replace the sensor.
5. If the over range condition continues after you replace the sensor, contact RKI Instruments, Inc. for further instructions.

## Responding to Battery Alarms

---

**WARNING:** *The GasWatch 3 is not operational as a gas monitoring device during a dead battery alarm. Take the GasWatch 3 to a non-hazardous area and replace the battery as described in “Replacing the Battery” on page 68.*

---

The GasWatch 3 is fully functional during a low battery warning. However, only 10 days of operating time remain. The amount of time depends on LCD backlight use and alarm frequency. Replace the battery as described on pg.68 as soon as possible.

---

**NOTE:** Alarms and the LCD backlight consume battery power and reduce the amount of operating time remaining.

---

## Responding to Sensor Failure Alarms

1. Calibrate the sensor as described on pg.43.
2. If the sensor failure continues, replace the sensor as described on pg.72.
3. If the sensor failure condition continues after replacing the sensor, contact RKI Instruments, Inc. for further instructions.

## Responding to Clock Failure Alarms

A clock failure alarm occurs if the unit’s internal clock malfunctions.

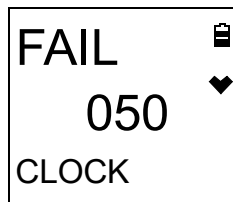

1. Press and release POWER/MODE to continue into Measuring Mode.

---

**CAUTION:** *There is no datalogging function if you operate the instrument after a clock failure.*

---

2. Attempt to set the date using the **DATE** item in User Mode (see pg.64).
3. If the date cannot be set correctly, contact RKI Instruments, Inc. as soon as possible.

## Responding to System Failure Alarms

1. If a system failure occurs, the system failure screen displays an error code as shown below:

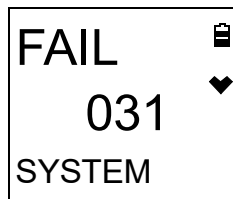



2. The error code meanings are shown in the table below:

**Table 5: Error Code Explanation**

Error Code	Explanation
000	ROM failure
010	RAM failure
020	FRAM failure
031	FLASH memory failure
082	Temperature sensor failure

3. If the error code is anything but 031, the instrument cannot be used. Contact RKI Instruments, Inc. as soon as possible.

If the error code is 031, press and release POWER/MODE to continue into Measuring Mode if the instrument must be used temporarily.

---

**CAUTION:** *There is no datalogging function if you operate the instrument after a 031 system failure. Contact RKI Instruments, Inc. as soon as possible.*

---

## Data Logging

The GasWatch 3 logs Measuring Mode gas readings, alarm data, and calibration data to its internal memory. Logged data can be download it to a computer via the infrared communications port on the front of the unit.

The data logging capacity depends on how often the GasWatch 3 stores data and how often the GasWatch 3 is turned on and off. The table below illustrates how much data logging time is available for the various interval times. It assumes that the unit is only turned on once and there are no alarms. The data logging interval time must be set using the GasWatch 3 Datalogging Program.

**Table 6: Data Logging Capacity**

Interval Time	Data Logging Capacity
10 seconds	10 hours
20 seconds	20 hours
30 seconds	30 hours
1 minute	60 hours
3 minutes	180 hours
5 minutes	300 hours
10 minutes	600 hours

To utilize the GasWatch 3's downloading capability, you need:

- PC with Windows 7, Windows 8, or Windows 10
- IrDA port or IrDA/USB cable (cable available from RKI Instruments, Inc.)
- GasWatch 3 Datalogging Program (available at [www.rkiinstruments.com/gw3](http://www.rkiinstruments.com/gw3)).

For a complete description of the Datalogging Program and procedures for downloading data to a computer, see the GasWatch 3 Datalogging Program Operator's Manual.

# Chapter 4: Display Mode

This section describes Display Mode which is accessible from Measuring Mode. See Table 7 below for a list of Display Mode’s menu items, a short description of each item, and the page number for further description.

**Table 7: Display Mode Menu Items**

Display Mode Menu Item	Description
PEAK (pg.28)	Displays the Peak reading.
STEL (pg.28)	Displays the STEL reading.
TWA (pg.29)	Displays the TWA reading.
USER ID (pg.29) <sup>A</sup>	View and/or change the User ID.
STN ID (pg.30) <sup>A</sup>	View and/or change the Station ID.
CAL.DATA (pg.31) <sup>B</sup>	Displays the last calibration date.
BP.DATA (pg.31) <sup>C</sup>	Displays the last bump test date.
DATE (pg.32)	Displays the current date and time.
TEMP (pg.32)	Displays the current temperature.
ALARM--P (pg.32)	View alarm points.
BUZZ.VOL (pg.33) <sup>D</sup>	Set the buzzer volume to <b>LO</b> or <b>HI</b> (factory setting).
<p><sup>A</sup> Only appears if <b>DISP.SET</b> is set to <b>ON</b> in User Mode (factory setting) and if <b>ID DISP</b> is set to <b>ON</b> in Maintenance Mode (factory setting is <b>OFF</b>).</p> <p><sup>B</sup> Only appears if <b>CAL.RMDR</b> is set to <b>ON</b> in User Mode (factory setting).</p> <p><sup>C</sup> Only appears if <b>BP.RMDR</b> is set to <b>ON</b> in User Mode (factory setting is <b>OFF</b>).</p> <p><sup>D</sup> Only appears if <b>DISP.SET</b> is set to <b>ON</b> in User Mode (factory setting).</p>	

## Tips for Using Display Mode

- To enter Display Mode and scroll from one item to the next or skip an item when a question is asked, press and release POWER/MODE.
- To enter an item, press and release AIR.
- To change a flashing parameter, press and release AIR. To reverse the movement in a list (ie. from down to up or vice versa):
  - a. Press and hold AIR.
  - b. Immediately press POWER/MODE and then release both buttons.

- To exit from an entered-information screen and go back to Measuring Mode, press and release POWER/MODE until you get to the Measuring Mode screen.

---

**NOTE:** Each screen displays for 20 seconds. If you do not press a button within 20 seconds, the GasWatch 3 automatically returns to Measuring Mode.

---

---

## Peak Screen (PEAK)

The peak screen displays the highest concentration detected since the GasWatch 3 was turned on. The peak reading is stored until a higher level is detected, the peak reading is cleared, or the GasWatch 3 is turned off.

The lunch break feature enables the GasWatch 3 to save the peak reading when it is turned off so it can continue with the same peak when it is turned on again (see pg.14).

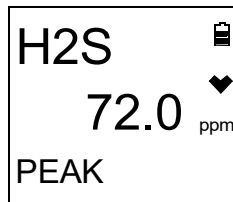

To clear the peak reading, do the following:

---

**NOTE:** If **Password Protection** is set to **On** using the GW-3 Series Setup Program, the peak reading cannot be cleared.

---

1. After entering Display Mode, press and release POWER/MODE until **PEAK** appears.
2. Press and hold AIR until the screen prompts you to release it.

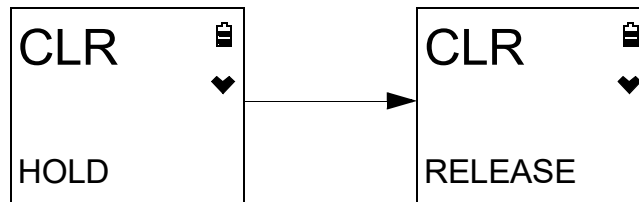

3. The peak reading is reset and the unit returns to the Peak Screen.

If you do not want to clear the peak reading, release AIR before the above screen sequence occurs. The unit returns to the Peak Screen.

---

## STEL Screen (STEL)

The STEL Screen displays the short term exposure limit (STEL) reading. The STEL reading is the average reading *over the last 15 minutes*.

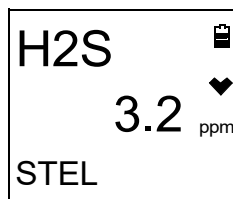

---

## TWA Screen (TWA)

The TWA Screen displays the time weighted average (TWA) reading.

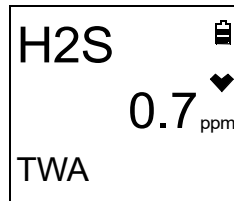

The TWA reading is the average reading *over the last 8 hours*. If 8 hours have not elapsed since the last time the TWA reading was cleared, the average is still calculated over 8 hours. The missing readings are assigned a value of 0. If **LUNCH** is set to **OFF** (factory setting), the TWA is cleared when the GasWatch 3 is turned off.

If **LUNCH** is set to **ON**, the GasWatch 3 remembers the TWA reading when it is turned off and can continue accumulation when it is turned on again (see pg.14).

---

## Changing the User ID (USER ID)

This screen only appears if **DISP.SET** in User Mode is set to **ON** (factory setting) and if **ID DISP** in Maintenance Mode is set to **ON** (factory setting is **OFF**).

Use this screen to select a user ID from the 128 user IDs that are stored in the GasWatch 3's memory. Before a user ID is selected on a brand new instrument, the user ID is "-----". The factory-installed user IDs have a "U\_ID\_XXX" format.

The user ID provides a way to identify the GasWatch 3 user during a data logging session.

User IDs can only be selected in this menu item. In order to edit the 128 user IDs, you must use the GasWatch 3 Datalogging Program or GasWatch 3 Setup Program.

1. After entering Display Mode, press and release **POWER/MODE** until the **USER ID** screen sequence appears.

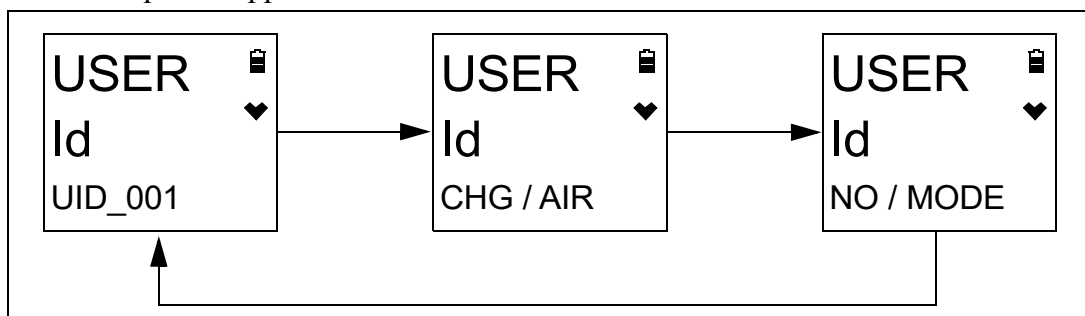

2. To change the User ID, press and release **AIR**. The current User ID flashes.

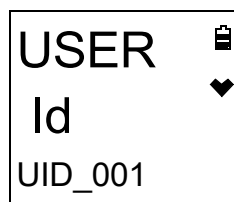

3. Use **AIR** to scroll to the desired User ID.
4. Press and release **POWER/MODE** to save the User ID and return to the **USER ID** screen in Display Mode.

## Changing the Station ID (STN ID)

This screen only appears if **DISP.SET** in User Mode is set to **ON** (factory setting) and if **ID DISP** in Maintenance Mode is set to **ON** (factory setting is **OFF**).

Use this screen to select a station ID from the 128 station IDs that are stored in the GasWatch 3's memory. Before a station ID is selected on a brand new instrument, the station ID is "-----". The factory-installed station IDs have a "S\_ID\_XXX" format.

The station ID provides a way to identify the GasWatch 3 location during a data logging session.

User IDs can only be selected in this menu item. In order to edit the 128 user IDs, you must use the GasWatch 3 Datalogging Program or GasWatch 3 Setup Program.

1. After entering Display Mode, press and release **POWER/MODE** until the **STN ID** screen sequence appears.

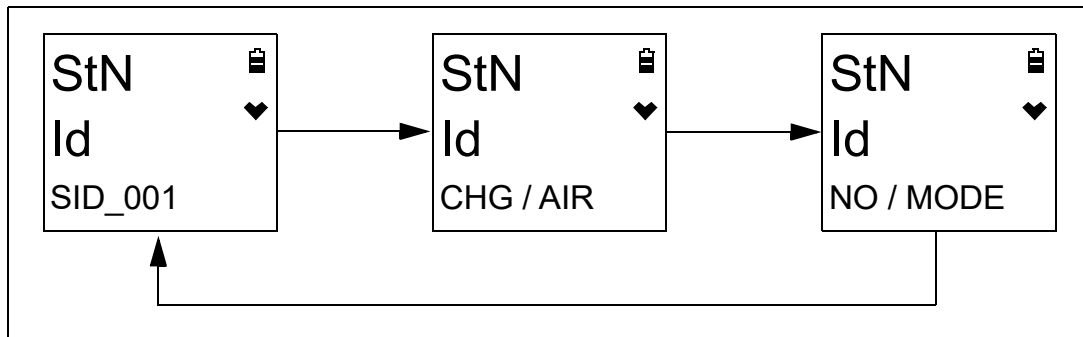

2. To change the Station ID, press and release **AIR**. The current Station ID flashes.

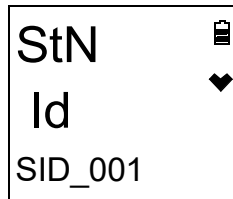

3. Use **AIR** to scroll to the desired Station ID.
4. Press and release **POWER/MODE** to save the Station ID and return to the **STN ID** screen in Display Mode.

---

## Last Successful Calibration Date (CAL.DATA)

The **CAL.DATA** screen shows the date of the last successful calibration. This screen only appears if **CAL.RMDR** is set to **ON** (factory setting).

1. After entering Display Mode, press and release **POWER/MODE** until the **CAL.DATA** screen sequence appears.

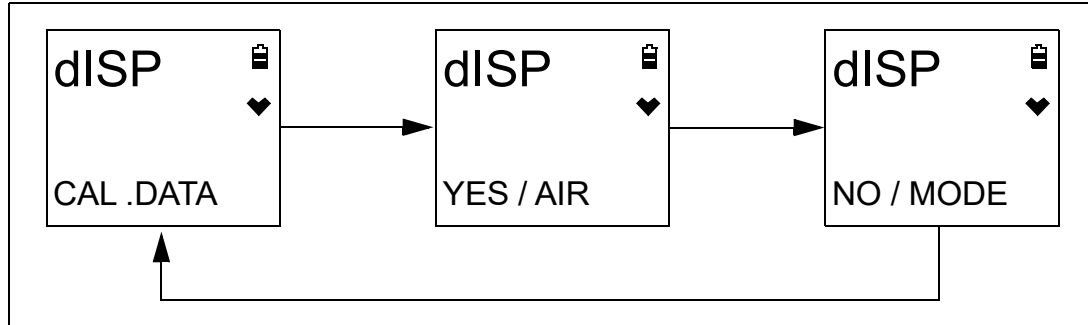

2. Press **AIR** to enter the **CAL.DATA** screen. The date of the last successful calibration displays.

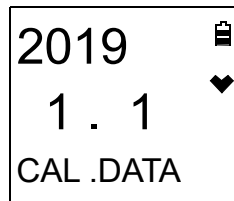

3. Press and release **POWER/MODE** to return to the **CAL.DATA** screen in Display Mode.

---

## Last Successful Bump Test Date (BP.DATA)

The **BP.DATA** screen shows the date of the last successful bump test. This screen only appears if **BP.RMDR** is set to **ON** (factory setting is **OFF**).

1. After entering Display Mode, press and release **POWER/MODE** until the **BP.DATA** screen sequence appears.

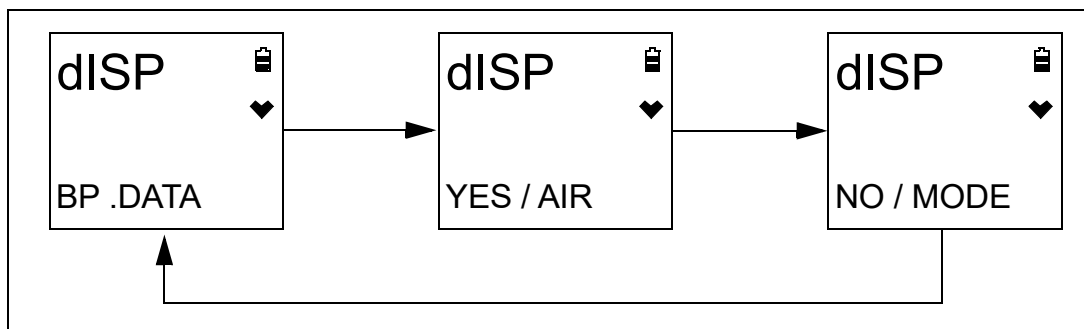

2. Press AIR to enter the **BP.DATA** screen. The date of the last successful bump test displays.

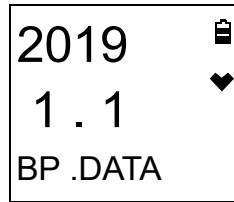

3. When you are done viewing the last bump test date, press and release POWER/MODE to return to the **BP.DATA** screen in Display Mode.

---

## Date/Time Screen (DATE)

The **DATE** screen shows the instrument's date and time.

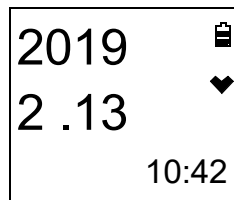

---

## Temperature Screen (TEMP)

The **TEMP** screen shows the surrounding area's temperature.

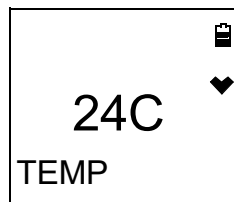

---

## Alarm Points Screen (ALARM--P)

The Alarm Points Screen shows the gas alarm settings.

1. After entering Display Mode, press and release POWER/MODE until the **ALARM--P** screen sequence appears.

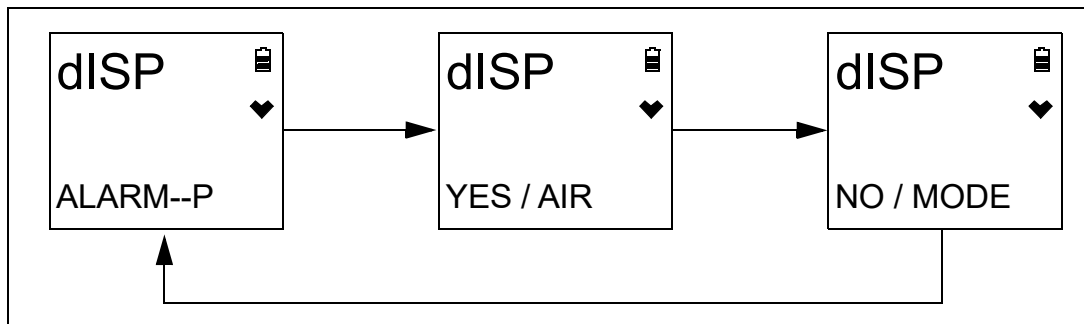



2. Press and release AIR. The Full Scale Setting screen appears.
3. Use AIR to scroll through the Warning, Alarm, Alarm H, STEL, and TWA settings.

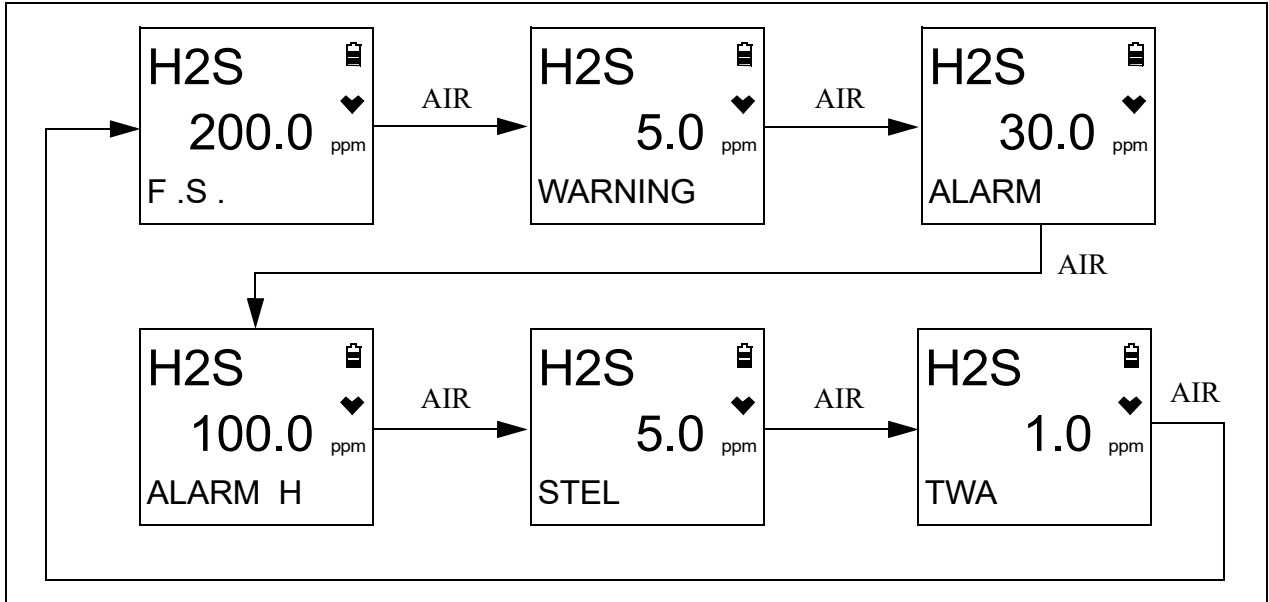

4. Press and release POWER/MODE to return to the Alarm Points Screen.

## Adjusting the Buzzer Volume (BUZZ.VOL)

The **BUZZ.VOL** screen allows you to adjust the volume of the instrument's buzzer. This screen only appears if **DISP.SET** in User Mode is set to **ON** (factory setting).

**HI** (factory setting): Buzzer volume is high.

**LO**: Buzzer volume is low.

1. While in Display Mode, press and release POWER/MODE until **BUZZ.VOL** appears. The current setting displays on the top line.

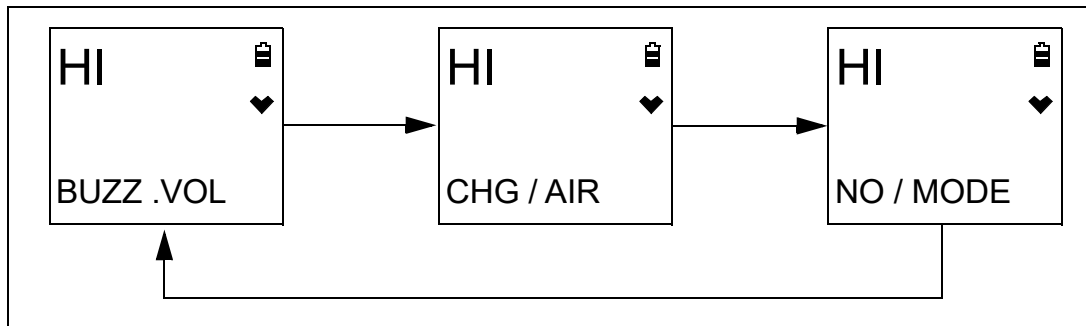

2. Press and release AIR. The current setting flashes.
3. Use AIR to display the desired setting.
4. Press and release POWER/MODE to save the setting and return to the **BUZZ.VOL** item in Display Mode.

# Chapter 5: User Mode and Calibration

## Overview

This section describes the GasWatch 3 in User Mode. See Table 8 below for a list of the items found in User Mode, the page that the item’s instructions can be found on, and a short description of the item.

**Table 8: User Mode Menu Items**

User Mode Menu Item	Description		
BUMP (pg.38)	Perform a bump test.		
	BUMP	Perform a bump test.	
	START	Begin the warmup sequence and enter Measuring Mode.	
	ESCAPE	Return to the <b>BUMP</b> menu item.	
GAS CAL (pg.43)	Perform a fresh air adjustment, perform a span adjustment, change the calibration gas concentration.		
	AIR (pg.43)	Perform a fresh air adjustment.	
	A-CAL (pg.44) or E-CAL (pg.48) depending on E-CAL User Mode setting*	A-CAL (or E-CAL)	Perform a span adjustment.
		START	Begin the warmup sequence and enter Measuring Mode.
		CAL-P	Set the calibration gas concentration.
		ESCAPE	Return to the <b>A-CAL</b> item in the <b>GAS CAL</b> menu.
	ESCAPE	Return to the <b>GAS CAL</b> item in User Mode.	
CAL SET (pg.52)	Change parameters related to calibration.		
	CAL.RMDR (pg.52)	<b>ON (factory setting):</b> The instrument notifies the user upon startup when a calibration is due. Notification type depends on <b>CAL.EXPD</b> setting below. <b>CAL.DATA</b> screen appears in Display Mode. <b>OFF:</b> No notification upon startup when a calibration is due. <b>CAL.DATA</b> screen does not appear in Display Mode.	
	CAL.INT (pg.53)	How often the instrument needs to be calibrated. Options: <b>1 - 1000</b> days (factory setting is <b>90</b> days)	
	CAL.EXPD (pg.53)	Defines what action must be taken if a calibration is due upon startup. <b>CONFIRM (factory setting):</b> Press and release AIR to acknowledge that calibration is due and continue to Measuring Mode. <b>CANT.USE:</b> Cannot enter Measuring Mode until a successful calibration is performed. <b>NONE:</b> A screen indicates that calibration is due but warmup sequence continues.	
	ESCAPE	Return to the <b>CAL SET</b> item in User Mode.	

**Table 8: User Mode Menu Items**

User Mode Menu Item	Description	
BUMP.SET (pg.54)	Change parameters related to bump testing.	
	SETTING (pg.55)	GAS.TIME How long gas is applied during a bump test. Choices: <b>30</b> (factory setting), <b>45</b> , <b>60</b> , <b>90</b> seconds
		CHECK Percentage of calibration gas concentration that the bump test reading must be within in order to pass bump. Options: <b>10%</b> , <b>20%</b> , <b>30%</b> , <b>40%</b> , <b>50%</b> (factory setting)
		CAL.TIME How long gas is applied during a calibration. <b>GAS.TIME</b> is deducted from this time. Options: <b>90</b> (factory setting) or <b>120</b> seconds
		A-CAL <b>ON</b> (factory setting): If a bump test fails, a calibration automatically starts. <b>OFF</b> : If a bump test fails, a calibration does not automatically start.
		ESCAPE Return to the <b>SETTING</b> item in the <b>BUMP SET</b> menu.
	BP.RMDR (pg.57)	<b>ON</b> : The instrument notifies the user upon startup when a bump test is due. Notification type depends on <b>BP.EXPD</b> setting below. <b>BP.DATA</b> screen appears in Display Mode. <b>OFF</b> (factory setting): No notification upon startup when a bump test is due. <b>BP.DATA</b> screen does not appear in Display Mode.
	BP.INT (pg.57)	How often the instrument needs to be bump tested. Options: <b>0</b> - <b>30</b> days (factory setting is <b>30</b> days)
ALARM-P (pg.58)	BP.EXPD (pg.57)	Defines what action must be taken if a bump test is due upon startup. <b>CONFIRM</b> (factory setting): Press and release AIR to acknowledge that bump test is due and continue to Measuring Mode. <b>CANT.USE</b> : Cannot enter Measuring Mode until a successful bump test is performed. <b>NONE</b> : A screen indicates that bump test is due but warmup sequence continues.
	ESCAPE	Return to the <b>BUMP SET</b> item in User Mode.
LUNCH (pg.60)	Set alarm points (WARNING, ALARM, ALARM H, STEL, TWA) and/or reset all alarms to their default settings.	
	<b>ON</b> : Lunch break feature is on. Instrument asks if you want to resume TWA and PEAK readings at startup. <b>OFF</b> (factory setting): Lunch break feature is off. Instrument resets TWA and PEAK readings every time it's turned on.	

**Table 8: User Mode Menu Items**

User Mode Menu Item	Description						
BEEP (pg.61)	<p>Set confirmation beep parameters.</p> <table border="1" data-bbox="493 285 1472 856"> <tr> <td data-bbox="493 285 683 688">BEEP.SEL (pg.61)</td> <td data-bbox="683 285 1472 688"> <p><b>LED:</b> LEDs flash and instrument vibrates based on interval defined in <b>BEEP.INT</b> to confirm instrument is still operating.  <b>BUZZER:</b> Buzzer sounds and instrument vibrates based on interval defined in <b>BEEP.INT</b> to confirm instrument is still operating.  <b>LED+BUZ:</b> LEDs flash, buzzer sounds, and instrument vibrates based on interval defined in <b>BEEP.INT</b> to confirm instrument is still operating.  <b>BMP/CAL:</b> LEDs flash based on interval defined in <b>BEEP.INT</b> if bump test or calibration is due regardless of whether <b>BP.RMDR</b> and/or <b>CAL.RMDR</b> are set to <b>ON</b>.  <b>OFF (factory setting):</b> No alerts to confirm instrument is still operating or that a bump test or calibration is due.</p> </td> </tr> <tr> <td data-bbox="493 688 683 806">BEEP.INT (pg.62)</td> <td data-bbox="683 688 1472 806"> <p>Confirmation alert interval. Confirmation type defined in <b>BEEP.SEL</b>. Options: <b>0.5</b> minute and <b>1</b> to <b>99</b> minutes in 1 minute increments. The factory setting is <b>5</b> minutes.</p> </td> </tr> <tr> <td data-bbox="493 806 683 856">ESCAPE</td> <td data-bbox="683 806 1472 856"> <p>Return to the <b>BEEP</b> item in User Mode.</p> </td> </tr> </table>	BEEP.SEL (pg.61)	<p><b>LED:</b> LEDs flash and instrument vibrates based on interval defined in <b>BEEP.INT</b> to confirm instrument is still operating.  <b>BUZZER:</b> Buzzer sounds and instrument vibrates based on interval defined in <b>BEEP.INT</b> to confirm instrument is still operating.  <b>LED+BUZ:</b> LEDs flash, buzzer sounds, and instrument vibrates based on interval defined in <b>BEEP.INT</b> to confirm instrument is still operating.  <b>BMP/CAL:</b> LEDs flash based on interval defined in <b>BEEP.INT</b> if bump test or calibration is due regardless of whether <b>BP.RMDR</b> and/or <b>CAL.RMDR</b> are set to <b>ON</b>.  <b>OFF (factory setting):</b> No alerts to confirm instrument is still operating or that a bump test or calibration is due.</p>	BEEP.INT (pg.62)	<p>Confirmation alert interval. Confirmation type defined in <b>BEEP.SEL</b>. Options: <b>0.5</b> minute and <b>1</b> to <b>99</b> minutes in 1 minute increments. The factory setting is <b>5</b> minutes.</p>	ESCAPE	<p>Return to the <b>BEEP</b> item in User Mode.</p>
BEEP.SEL (pg.61)	<p><b>LED:</b> LEDs flash and instrument vibrates based on interval defined in <b>BEEP.INT</b> to confirm instrument is still operating.  <b>BUZZER:</b> Buzzer sounds and instrument vibrates based on interval defined in <b>BEEP.INT</b> to confirm instrument is still operating.  <b>LED+BUZ:</b> LEDs flash, buzzer sounds, and instrument vibrates based on interval defined in <b>BEEP.INT</b> to confirm instrument is still operating.  <b>BMP/CAL:</b> LEDs flash based on interval defined in <b>BEEP.INT</b> if bump test or calibration is due regardless of whether <b>BP.RMDR</b> and/or <b>CAL.RMDR</b> are set to <b>ON</b>.  <b>OFF (factory setting):</b> No alerts to confirm instrument is still operating or that a bump test or calibration is due.</p>						
BEEP.INT (pg.62)	<p>Confirmation alert interval. Confirmation type defined in <b>BEEP.SEL</b>. Options: <b>0.5</b> minute and <b>1</b> to <b>99</b> minutes in 1 minute increments. The factory setting is <b>5</b> minutes.</p>						
ESCAPE	<p>Return to the <b>BEEP</b> item in User Mode.</p>						
BL TIME (pg.62)	<p>How long the back light stays on after the last button press. Options: <b>0 - 255</b> seconds or <b>OFF</b>. The factory setting is <b>30</b> seconds.</p>						
KEY.TONE (pg.63)	<p><b>ON (factory setting):</b> Buzzer sounds when button is pressed.  <b>OFF:</b> Buzzer does not sound when button is pressed.</p>						
DISP.SET (pg.63)	<p><b>OFF:</b> <b>USER ID</b>, <b>STN ID</b>, and <b>BUZZ.VOL</b> items do not appear in Display Mode.  <b>ON (factory setting):</b> <b>BUZZ.VOL</b> item appears in Display Mode. <b>USER ID</b> and <b>STN ID</b> items appear if <b>ID DISP</b> in Maintenance Mode is also set to <b>ON</b>.</p>						
ZERO.SUP (pg.63)**	<p><b>ON (factory setting):</b> Not intended for field adjustment. The suppression value is 2 ppm.</p>						
ZERO.FLW (pg.64)***	<p><b>ON (factory setting):</b> Not intended for field adjustment.</p>						
E-CAL (pg.64)	<p><b>XX seconds:</b> <b>E-CAL</b> appears in <b>GAS CAL</b> instead of <b>A-CAL</b>.  <b>OFF (factory setting):</b> <b>E-CAL</b> does not appear in <b>GAS CAL</b>.</p>						
DATE (pg.64)	<p>Set the instrument's date and time.</p>						
PASS-W (pg.65)	<p><b>ON:</b> User Mode is password-protected. Factory-set password is <b>0405</b>.  <b>OFF (factory setting):</b> User Mode is not password-protected.</p>						
ROM/SUM (pg.66)	<p>View the firmware information for the GasWatch 3's sensor board and main board.</p>						
START (pg.66)	<p>Press and release POWER/MODE to begin the warmup sequence and enter Measuring Mode.</p>						
<p>* If a <b>CYL SEL</b> screen appears in <b>A-CAL/E-CAL</b>, <b>CYL.DISP</b> is set to <b>ON</b> in Maintenance Mode.  ** Only appears if <b>ZSUP.DSP</b> is set to <b>ON</b> in Maintenance Mode.  *** Only appears if <b>ZFLW.DSP</b> is set to <b>ON</b> in Maintenance Mode.</p>							

# Entering User Mode

**WARNING:** *The GasWatch 3 is not in operation as a gas detector while in User Mode.*

1. Take the GasWatch 3 to a non-hazardous location and turn it off if it is on.
2. Press and hold AIR, then press and hold POWER/MODE. When you hear a beep, release the buttons.
3. The screen that appears depends on the setting of User Mode's **PASS-W** item.  
If **PASS-W** is set to **OFF** (factory setting), continue with Step 6.  
If **PASS-W** is set to **ON**, continue with Step 4.

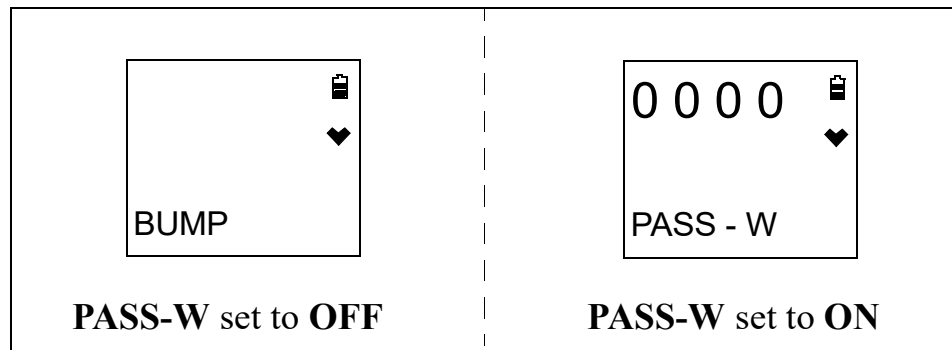

4. If **PASS-W** is set to **ON** in User Mode, a password screen appears and the first digit flashes. The factory-set password is **0405** but it can be changed.
5. Use AIR to select each password number then press POWER/MODE to save it and move on to the next number. To go back a number, press and hold AIR and POWER/MODE for a few seconds. To reverse the direction of change (ie. from increasing to decreasing or vice versa):
  - a. Press and hold AIR.
  - b. Immediately press POWER/MODE and then release both buttons.
6. The **BUMP** item displays.

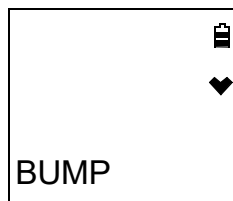

7. Use AIR to move through the User Mode items.

---

## Tips for Using User Mode

- To scroll from one item to the next, press and release AIR. To reverse the scrolling direction:
  - a. Press and hold AIR.
  - b. Immediately press POWER/MODE and then release both buttons.
  - c. The scrolling direction returns to the original direction when you exit and reenter a menu.
- To skip an item when a question is asked, press and release AIR.
- To enter an item and to save any changes, press and release POWER/MODE.
- To change a flashing parameter, press and release AIR. To reverse the direction of change (ie. from increasing to decreasing or vice versa):
  - a. Press and hold AIR.
  - b. Immediately press POWER/MODE and then release both buttons.
- To exit an entered item without saving a change, press and hold AIR and POWER/MODE for a few seconds.

---

## Performing a Bump Test (BUMP)

Bump test the instrument before each day's use with a known concentration of the target gas. The instrument does not need to be calibrated unless it does not pass the bump test.

To bump test the GasWatch 3, you need:

- Calibration gas cylinder (RKI Instruments recommends using 25 ppm H<sub>2</sub>S)
  - 0.25 LPM fixed flow regulator
  - Non-absorbent tubing
  - Calibration cup
1. Confirm that the GasWatch 3's calibration gas value matches the concentration listed on the calibration gas cylinder as described on pg.51.
  2. Install the calibration cup onto the GasWatch 3. The calibration cup has an indicated flow direction. Be sure the calibration cup is installed in the correct direction and that it is pushed on all the way.

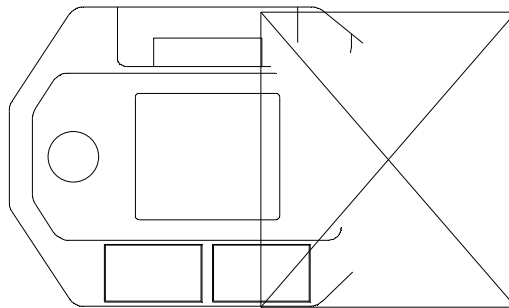

3. Use the tubing to connect the regulator to the inlet of the calibration cup.

4. While in User Mode, press AIR to scroll to **BUMP**.

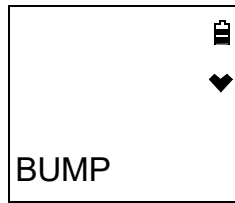

5. Press and release POWER/MODE. The display shows the calibration value (see pg.51 if the calibration value does not match the calibration gas cylinder's concentration).

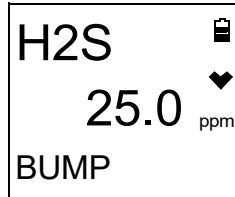

6. It is important to vent the regulator while installing it onto the cylinder. Venting the regulator during installation helps prevent air from getting into the cylinder and degrading the gas. Open the 0.25 LPM regulator by turning the knob counterclockwise and install it onto the cylinder.
7. Press and release POWER/MODE.
8. The gas reading flashes, the bottom of the screen alternates between "APLY" and "BUMP", and the bottom of the screen counts down from the time set in **BUMP.SET\SETTING\GAS.TIME**.

To back out of the gas application screen without performing the bump test, press and release AIR and POWER/MODE together.

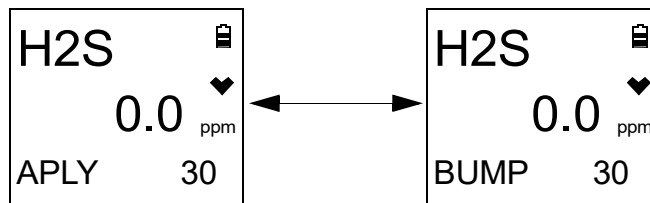

9. At the end of the countdown, the instrument analyzes the results. Follow the flow chart to determine the bump test outcome.

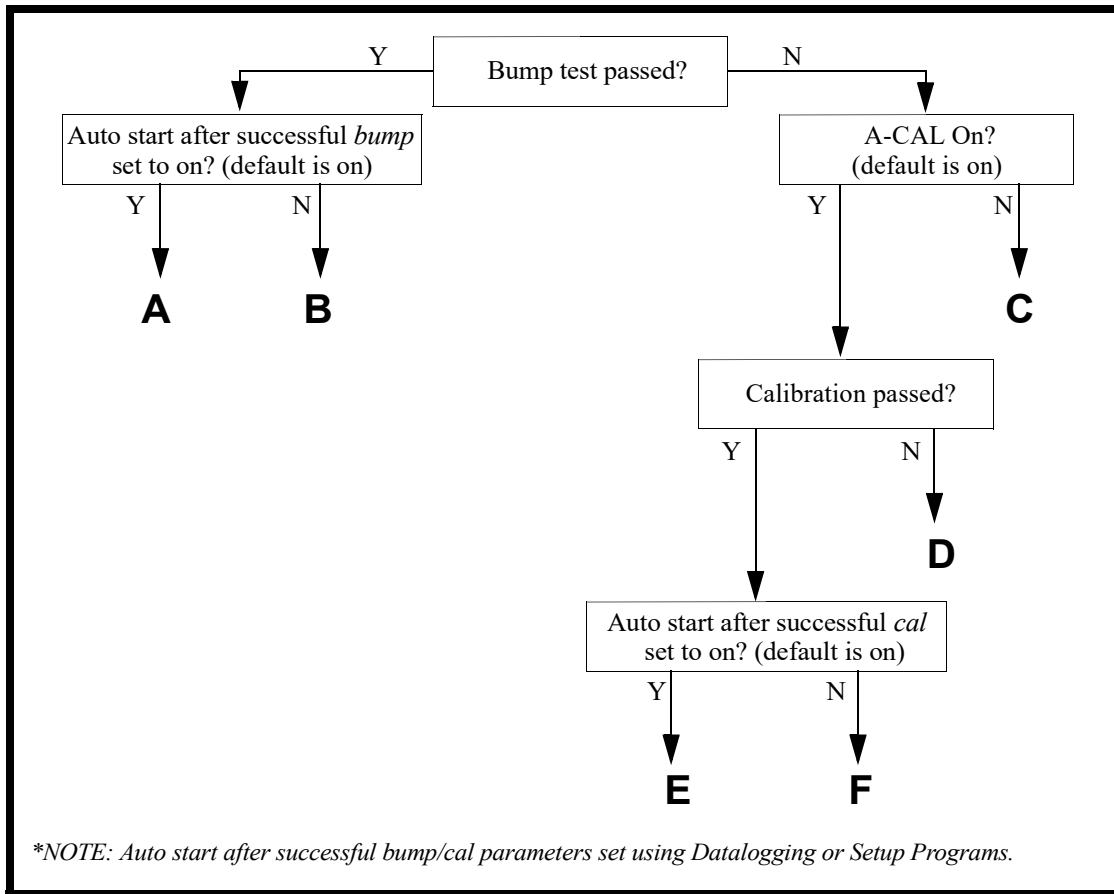
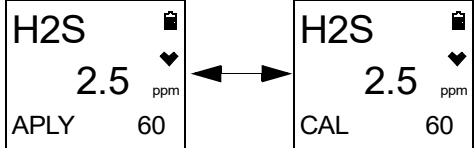
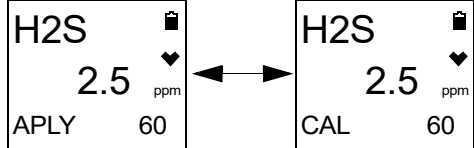
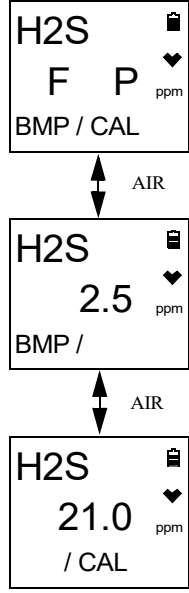
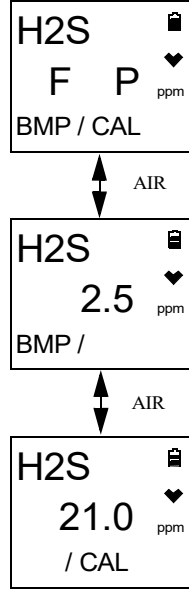

**Figure 5: Bump Test Flow Chart**

Option A from Flow Chart	Option B from Flow Chart
<ul style="list-style-type: none"> <li>• Bump test passed</li> <li>• Auto Start After Successful Bump set to ON (factory setting)</li> </ul>	<ul style="list-style-type: none"> <li>• Bump test passed</li> <li>• Auto Start After Successful Bump set to OFF (factory setting is ON)</li> </ul>
<ol style="list-style-type: none"> <li>1. The instrument indicates that the bump test passed. Use AIR to scroll between the bump test result and the bump test gas reading.</li> </ol> <div style="display: flex; justify-content: space-around; align-items: center;"> <div style="border: 1px solid black; padding: 5px; text-align: center;"> <p>H2S </p> <p>P </p> <p>BMP/CAL</p> </div> <div style="text-align: center;"> <p>AIR</p> <p>↔</p> </div> <div style="border: 1px solid black; padding: 5px; text-align: center;"> <p>H2S </p> <p>23.5 </p> <p>BMP /</p> </div> </div> <ol style="list-style-type: none"> <li>2. Close the regulator.</li> <li>3. Unscrew the regulator.</li> <li>4. Remove the calibration cup.</li> <li>5. Press and release POWER/MODE to enter Measuring Mode.</li> </ol>	<ol style="list-style-type: none"> <li>1. The instrument indicates that the bump test passed. Use AIR to scroll between the bump test result and the bump test gas reading.</li> </ol> <div style="display: flex; justify-content: space-around; align-items: center;"> <div style="border: 1px solid black; padding: 5px; text-align: center;"> <p>H2S </p> <p>P </p> <p>BMP/CAL</p> </div> <div style="text-align: center;"> <p>AIR</p> <p>↔</p> </div> <div style="border: 1px solid black; padding: 5px; text-align: center;"> <p>H2S </p> <p>23.5 </p> <p>BMP /</p> </div> </div> <ol style="list-style-type: none"> <li>2. Close the regulator.</li> <li>3. Unscrew the regulator.</li> <li>4. Remove the calibration cup.</li> <li>5. Press and release POWER/MODE to return to the <b>START</b> item in the <b>BUMP</b> menu.</li> <li>6. Press and release POWER/MODE to enter Measuring Mode.</li> </ol>



Option C from Flow Chart	Option D from Flow Chart
<ul style="list-style-type: none"> <li>• Bump test failed</li> <li>• A-CAL set to OFF (factory setting is ON)</li> </ul>	<ul style="list-style-type: none"> <li>• Bump test failed</li> <li>• A-CAL set to ON (factory setting)</li> <li>• Calibration failed</li> </ul>
<p>1. The instrument indicates that the bump test failed. The LEDs flash and the buzzer sounds. Use AIR to scroll between the result and the reading.</p> <div data-bbox="397 443 831 596" style="border: 1px solid black; padding: 5px; margin: 10px 0;"> </div> <ol style="list-style-type: none"> <li>2. Close the regulator.</li> <li>3. Unscrew the regulator.</li> <li>4. Remove the calibration cup.</li> <li>5. Press and release POWER/MODE to return to the bump test start screen in the <b>BUMP</b> menu.</li> <li>6. Use AIR to scroll to <b>START</b> and press and release POWER/MODE to enter Measuring Mode.</li> <li>7. Calibrate the GasWatch 3 as soon as possible.</li> </ol>	<p>1. A calibration immediately and automatically starts. Continue to apply the calibration gas.</p> <p>2. The calibration time is the difference between the <b>GAS.TIME</b> and the <b>CAL.TIME</b> values defined in the <b>BUMP.SET\SETTING</b> item in User Mode.</p> <div data-bbox="885 562 1349 716" style="border: 1px solid black; padding: 5px; margin: 10px 0;"> </div> <p>3. The instrument shows the pass/fail results of the bump test/calibration. The LEDs flash and the buzzer sounds. Use AIR to scroll between the results and the readings.</p> <div data-bbox="1024 884 1206 1465" style="border: 1px solid black; padding: 5px; margin: 10px 0;"> </div> <ol style="list-style-type: none"> <li>4. Close the regulator.</li> <li>5. Unscrew the regulator.</li> <li>6. Remove the calibration cup.</li> <li>7. Press and release POWER/MODE to return to the bump test start screen in the <b>BUMP</b> menu.</li> <li>8. Use AIR to scroll to <b>START</b> and press and release POWER/MODE to enter Measuring Mode.</li> </ol>

Option E from Flow Chart	Option F from Flow Chart
<ul style="list-style-type: none"> <li>• Bump test failed</li> <li>• A-CAL set to ON (factory setting)</li> <li>• Calibration passed</li> <li>• Auto Start After Successful Cal set to ON (factory setting)</li> </ul>	<ul style="list-style-type: none"> <li>• Bump test failed</li> <li>• A-CAL set to ON (factory setting)</li> <li>• Calibration passed</li> <li>• Auto Start After Successful Cal set to OFF (factory setting is ON)</li> </ul>
<ol style="list-style-type: none"> <li>1. A calibration immediately and automatically starts. Continue to apply the calibration gas.</li> <li>2. The calibration time is the difference between the <b>GAS.TIME</b> and the <b>CAL.TIME</b> values defined in the <b>BUMP.SET\SETTING</b> item in User Mode.</li> </ol>	<ol style="list-style-type: none"> <li>1. A calibration immediately and automatically starts. Continue to apply the calibration gas.</li> <li>2. The calibration time is the difference between the <b>GAS.TIME</b> and the <b>CAL.TIME</b> values defined in the <b>BUMP.SET\SETTING</b> item in User Mode.</li> </ol>
	
<ol style="list-style-type: none"> <li>3. The instrument shows the pass/fail results of the bump test/calibration. Use AIR to scroll between the results and the readings.</li> </ol>	<ol style="list-style-type: none"> <li>3. The instrument shows the pass/fail results of the bump test/calibration. Use AIR to scroll between the results and the readings.</li> </ol>
	
<ol style="list-style-type: none"> <li>4. Close the regulator.</li> <li>5. Unscrew the regulator.</li> <li>6. Remove the calibration cup.</li> <li>7. Press and release POWER/MODE to enter Measuring Mode.</li> </ol>	<ol style="list-style-type: none"> <li>4. Close the regulator.</li> <li>5. Unscrew the regulator.</li> <li>6. Remove the calibration cup.</li> <li>7. Press and release POWER/MODE to return to the <b>START</b> item in the <b>BUMP</b> menu.</li> <li>8. Press and release POWER/MODE to enter Measuring Mode.</li> </ol>

---

## Performing a Calibration (GAS CAL)

- Bump test the instrument before each day's use with a known concentration of the target gas. A bump test can be done in User Mode's **BUMP** item or by applying gas in Measuring Mode. The instrument does not need to be calibrated unless it does not pass the User Mode bump test or does not respond appropriately, as defined by the user, in Measuring Mode.
- To fully calibrate the sensors, you must do a fresh air adjustment (**AIR CAL**) and a span adjustment (**A-CAL** or **E-CAL**).
- The GasWatch 3 can be calibrated using either **A-CAL** or **E-CAL** depending on the setting of the **E-CAL** User Mode item.

**A-CAL** (appears if **E-CAL** User Mode item is set to **OFF**): Apply gas for a period of time, then press and release **POWER/MODE** to perform the adjustment.

**E-CAL** (appears if **E-CAL** User Mode item is set to something besides **OFF**): As soon as gas is applied and the reading reaches 10% of the auto calibration value, the instrument counts down from the number of seconds specified in the **E-CAL** User Mode item and automatically performs the adjustment.

### Performing a Fresh Air Adjustment (AIR)

1. Find a fresh air environment, an environment of normal oxygen content (20.9%) that is free of toxic and combustible gases.
2. While in User Mode, press **AIR** to scroll to **GAS CAL**.

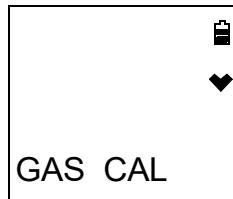

3. Press and release **POWER/MODE**. The **AIR** item appears.

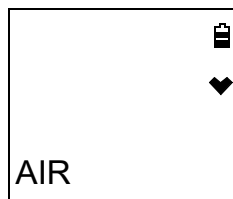

4. Press and release **POWER/MODE** to enter the **AIR** menu.

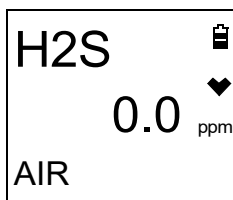

5. To return to the **AIR** menu without performing a fresh air adjustment, press and release **POWER MODE**.

6. Press and hold AIR until the screen prompts you to release it.

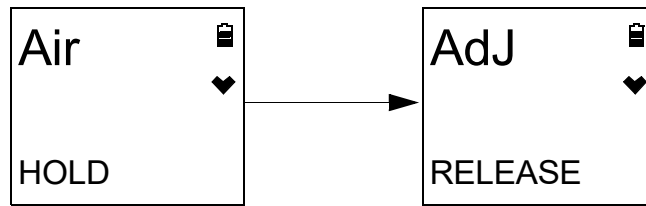

7. If the fresh air adjustment passes, the instrument returns to the **AIR** item in the **GAS CAL** menu.
8. If the fresh air adjustment fails, “FAIL AIR” displays. Press and release POWER/MODE to acknowledge the failure. See pg.67.

## Performing a Span Adjustment in A-CAL

The **A-CAL** item only appears if **E-CAL** in User Mode is set to **OFF** (factory setting). If **E-CAL** is set to **ON**, see pg.48 for calibration instructions.

### Preparing for Span Adjustment

To adjust the span on the GasWatch 3, you need:

- Calibration gas cylinder (RKI Instruments recommends using 25 ppm H<sub>2</sub>S)
  - 0.25 LPM fixed flow regulator
  - Non-absorbent tubing
  - Calibration cup
1. Confirm that the GasWatch 3’s calibration gas value matches the concentration listed on the calibration gas cylinder as described on pg.51.
  2. Install the calibration cup onto the GasWatch 3. The calibration cup has an indicated flow direction. Be sure the calibration cup is installed in the correct direction and that it is pushed on all the way.

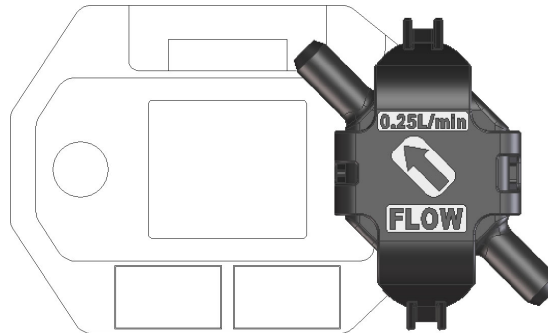

3. Use the tubing to connect the regulator to the inlet of the calibration cup.

## Performing a Span Adjustment

1. While in User Mode, press AIR to scroll to **GAS CAL**.

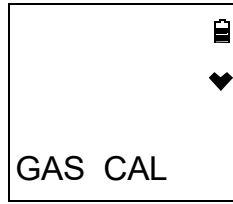

2. Press and release POWER/MODE. The **AIR** item appears.
3. Use AIR to scroll to the **A-CAL** item.

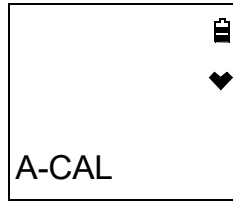

4. Press and release POWER/MODE. The display shows the calibration value (see pg.51 if the calibration value does not match the calibration gas cylinder's concentration).

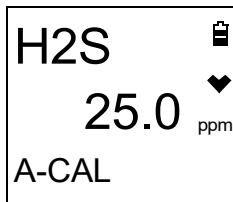

5. Press and release POWER/MODE.
6. The gas reading flashes and the bottom of the screen alternates between “APPLY” and “A-CAL”.

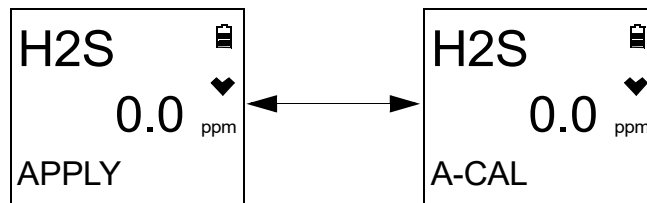

---

**NOTE:** To back out of the gas application screen without performing the calibration, press and release AIR and POWER/MODE together.

---

7. It is important to vent the regulator while installing it onto the cylinder. Venting the regulator during installation helps prevent air from getting into the cylinder and degrading the gas. Open the 0.25 LPM regulator by turning the knob counterclockwise and install it onto the cylinder.
8. Allow the gas to flow for 1 minute.
9. Press and release POWER/MODE.

10. Follow the flow chart to determine the calibration outcome.

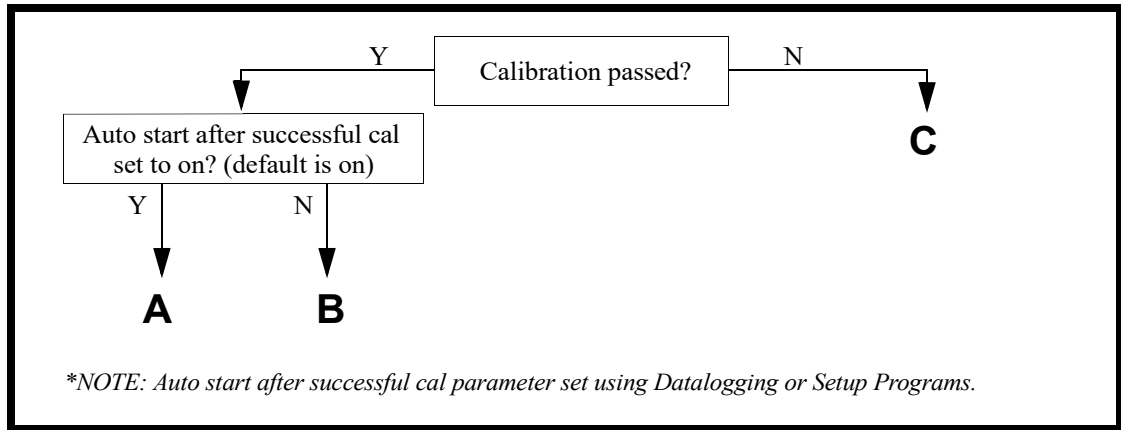

**Figure 6: Calibration Flow Chart**

Option A from Flow Chart	Option B from Flow Chart	Option C from Flow Chart
<ul style="list-style-type: none"> <li>• Calibration passed</li> <li>• Auto Start After Successful Cal set to ON (factory setting)</li> </ul>	<ul style="list-style-type: none"> <li>• Calibration passed</li> <li>• Auto Start After Successful Cal set to OFF (factory setting is ON)</li> </ul>	<ul style="list-style-type: none"> <li>• Calibration failed</li> </ul>
<ol style="list-style-type: none"> <li>The instrument indicates that the calibration passed.           <div data-bbox="233 424 412 575" style="border: 1px solid black; padding: 5px; margin: 10px 0;"> <p style="text-align: center;">PASS </p> <p style="text-align: right;">▼</p> <p style="text-align: center;">A-CAL</p> </div> </li> <li>The instrument shows the current gas reading.           <div data-bbox="233 669 412 821" style="border: 1px solid black; padding: 5px; margin: 10px 0;"> <p style="text-align: center;">H2S </p> <p style="text-align: center;">23.5 ppm</p> <p style="text-align: right;">▼</p> <p style="text-align: center;">A-CAL</p> </div> </li> <li>If <b>MAX.SPAN</b> is set to <b>ON</b> (default is <b>OFF</b>, see pg.88), the response reading's maximum adjustment is displayed. A maximum span of 50 ppm indicates that the reading could have been adjusted up to 50 ppm. If the maximum span value is close to the calibration gas value, the sensor should be replaced soon.           <p>The maximum adjustment is either twice the calibration value or full scale, whichever is lower.</p> <div data-bbox="233 1205 412 1356" style="border: 1px solid black; padding: 5px; margin: 10px 0;"> <p style="text-align: center;">H2S </p> <p style="text-align: center;">47.0 ppm</p> <p style="text-align: right;">▼</p> <p style="text-align: center;">MAX.SPAN</p> </div> </li> </ol> <ol style="list-style-type: none"> <li>Close the regulator.</li> <li>Unscrew the regulator.</li> <li>Remove the calibration cup.</li> <li>The instrument automatically begins its warmup sequence and enters Measuring Mode.</li> </ol>	<ol style="list-style-type: none"> <li>The instrument indicates that the calibration passed.           <div data-bbox="721 424 899 575" style="border: 1px solid black; padding: 5px; margin: 10px 0;"> <p style="text-align: center;">PASS </p> <p style="text-align: right;">▼</p> <p style="text-align: center;">A-CAL</p> </div> </li> <li>The instrument shows the current gas reading.           <div data-bbox="721 669 899 821" style="border: 1px solid black; padding: 5px; margin: 10px 0;"> <p style="text-align: center;">H2S </p> <p style="text-align: center;">23.5 ppm</p> <p style="text-align: right;">▼</p> <p style="text-align: center;">A-CAL</p> </div> </li> <li>If <b>MAX.SPAN</b> is set to <b>ON</b> (default is <b>OFF</b>, see pg.88), the response reading's maximum adjustment is displayed. A maximum span of 50 ppm indicates that the reading could have been adjusted up to 50 ppm. If the maximum span value is close to the calibration gas value, the sensor should be replaced soon.           <p>The maximum adjustment is either twice the calibration value or full scale, whichever is lower.</p> <div data-bbox="721 1205 899 1356" style="border: 1px solid black; padding: 5px; margin: 10px 0;"> <p style="text-align: center;">H2S </p> <p style="text-align: center;">47.0 ppm</p> <p style="text-align: right;">▼</p> <p style="text-align: center;">MAX.SPAN</p> </div> </li> </ol> <ol style="list-style-type: none"> <li>Close the regulator.</li> <li>Unscrew the regulator.</li> <li>Remove the calibration cup.</li> <li>The instrument continues to the <b>START</b> item in the <b>A-CAL</b> menu.</li> <li>Press and release POWER/MODE to enter Measuring Mode.</li> </ol>	<ol style="list-style-type: none"> <li>The instrument indicates that the calibration failed.           <div data-bbox="1208 424 1386 575" style="border: 1px solid black; padding: 5px; margin: 10px 0;"> <p style="text-align: center;">H2S </p> <p style="text-align: center;">FAIL </p> <p style="text-align: right;">ppm</p> <p style="text-align: center;">A-CAL</p> </div> </li> </ol> <ol style="list-style-type: none"> <li>Close the regulator.</li> <li>Unscrew the regulator.</li> <li>Remove the calibration cup.</li> <li>Press and release POWER/MODE to return to the calibration start screen in the <b>A-CAL</b> menu.</li> <li>See "Troubleshooting" on page 67.</li> </ol>

## Performing a Span Adjustment in E-CAL

The **E-CAL** item only appears if **E-CAL** in User Mode is set to **ON** (factory setting is **OFF**). If **E-CAL** is set to **OFF**, see pg.44 for calibration instructions.

### Preparing for Span Adjustment

To adjust the span on the GasWatch 3, you need:

- Calibration gas cylinder (RKI Instruments recommends using 25 ppm H<sub>2</sub>S)
  - 0.25 LPM fixed flow regulator
  - Non-absorbent tubing
  - Calibration cup
1. Confirm that the GasWatch 3's calibration gas value matches the concentration listed on the calibration gas cylinder as described on pg.51.
  2. Confirm that the regulator knob is turned all the way clockwise. Screw the 0.25 LPM fixed flow regulator onto the calibration cylinder.
  3. Install the calibration cup onto the GasWatch 3. The calibration cup has an indicated flow direction. Be sure the calibration cup is installed in the correct direction and that it is pushed on all the way.

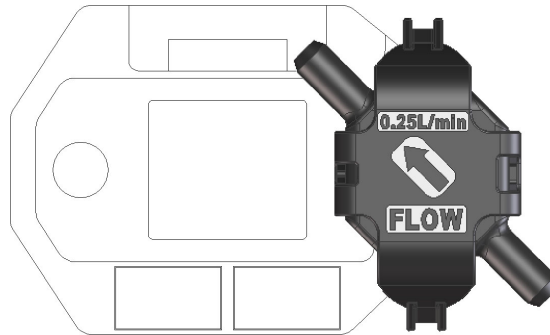

4. Use the tubing to connect the regulator to the inlet of the calibration cup.

### Performing a Calibration

1. While in User Mode, press **AIR** to scroll to **GAS CAL**.

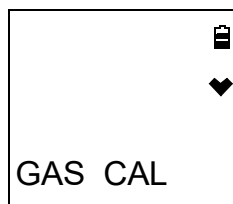

2. Press and release **POWER/MODE**. The **AIR** item appears.
3. Use **AIR** to scroll to the **E-CAL** item.

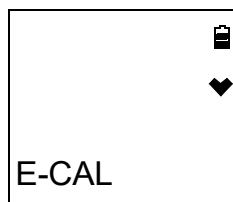



- Press and release POWER/MODE. The display shows the calibration value (see pg.51 if the calibration value does not match the calibration gas cylinder's concentration).

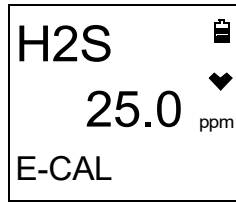

- Press and release POWER/MODE.
- The gas reading flashes and the bottom of the screen says "GAS IN".

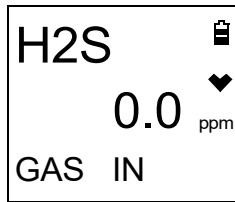

- Turn the regulator knob counterclockwise to open the regulator.
- Once the gas reading reaches 10% of the auto calibration value, the screen starts counting down from the time specified in the E-CAL User Mode item. In the example below, E-CAL is set to 60 seconds.

To back out of the gas application screen without performing the calibration, press and release AIR and POWER/MODE together.

If the reading never reaches 10% of the auto calibration value, press and release POWER/MODE to fail the calibration.

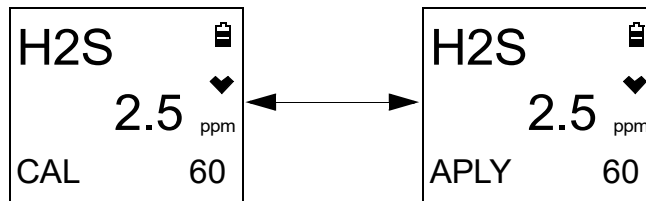

- At the end of the countdown, the instrument makes the span adjustment.
- Follow the flow chart to determine the calibration outcome.

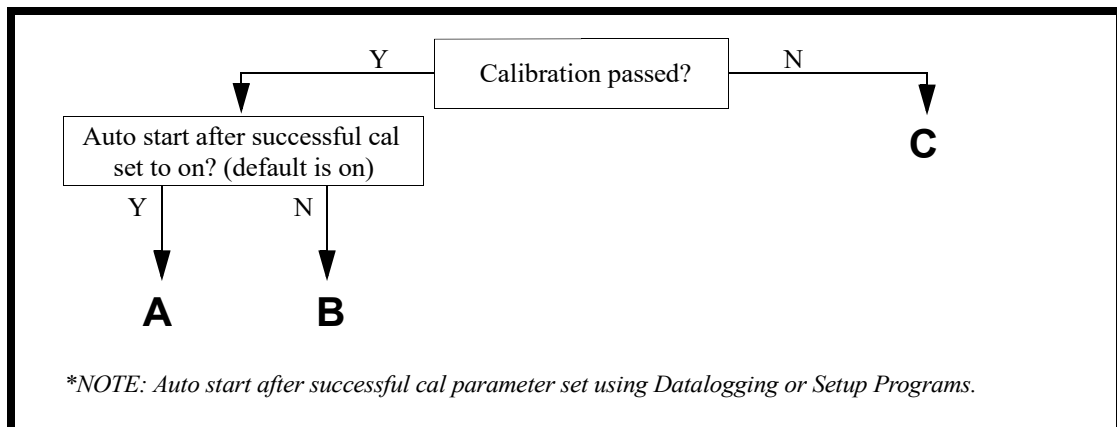

Figure 7: Calibration Flow Chart

Option A from Flow Chart	Option B from Flow Chart	Option C from Flow Chart
<ul style="list-style-type: none"> <li>• Calibration passed</li> <li>• Auto Start After Successful Cal set to ON (factory setting)</li> </ul>	<ul style="list-style-type: none"> <li>• Calibration passed</li> <li>• Auto Start After Successful Cal set to OFF (factory setting is ON)</li> </ul>	<ul style="list-style-type: none"> <li>• Calibration failed</li> </ul>
<ol style="list-style-type: none"> <li>The instrument indicates that the calibration passed.           <div data-bbox="233 424 412 575" style="border: 1px solid black; padding: 5px; margin: 10px 0;"> <p style="text-align: center;">PASS </p> <p style="text-align: right;">▼</p> <p style="text-align: center;">E-CAL</p> </div> </li> <li>The instrument shows the current gas reading.           <div data-bbox="233 669 412 821" style="border: 1px solid black; padding: 5px; margin: 10px 0;"> <p style="text-align: center;">H2S </p> <p style="text-align: center;">23.5 ppm</p> <p style="text-align: right;">▼</p> <p style="text-align: center;">E-CAL</p> </div> </li> <li>If <b>MAX.SPAN</b> is set to <b>ON</b> (default is <b>OFF</b>, see pg.88), the response reading's maximum adjustment is displayed. A maximum span of 50 ppm indicates that the reading could have been adjusted up to 50 ppm. If the maximum span value is close to the calibration gas value, the sensor should be replaced soon.           <p>The maximum adjustment is either twice the calibration value or full scale, whichever is lower.</p> <div data-bbox="233 1205 412 1356" style="border: 1px solid black; padding: 5px; margin: 10px 0;"> <p style="text-align: center;">H2S </p> <p style="text-align: center;">47.0 ppm</p> <p style="text-align: right;">▼</p> <p style="text-align: center;">MAX.SPAN</p> </div> </li> </ol> <ol style="list-style-type: none"> <li>Close the regulator.</li> <li>Unscrew the regulator.</li> <li>Remove the calibration cup.</li> <li>The instrument automatically begins its warmup sequence and enters Measuring Mode.</li> </ol>	<ol style="list-style-type: none"> <li>The instrument indicates that the calibration passed.           <div data-bbox="721 424 899 575" style="border: 1px solid black; padding: 5px; margin: 10px 0;"> <p style="text-align: center;">PASS </p> <p style="text-align: right;">▼</p> <p style="text-align: center;">E-CAL</p> </div> </li> <li>The instrument shows the current gas reading.           <div data-bbox="721 669 899 821" style="border: 1px solid black; padding: 5px; margin: 10px 0;"> <p style="text-align: center;">H2S </p> <p style="text-align: center;">23.5 ppm</p> <p style="text-align: right;">▼</p> <p style="text-align: center;">E-CAL</p> </div> </li> <li>If <b>MAX.SPAN</b> is set to <b>ON</b> (default is <b>OFF</b>, see pg.88), the response reading's maximum adjustment is displayed. A maximum span of 50 ppm indicates that the reading could have been adjusted up to 50 ppm. If the maximum span value is close to the calibration gas value, the sensor should be replaced soon.           <p>The maximum adjustment is either twice the calibration value or full scale, whichever is lower.</p> <div data-bbox="721 1205 899 1356" style="border: 1px solid black; padding: 5px; margin: 10px 0;"> <p style="text-align: center;">H2S </p> <p style="text-align: center;">47.0 ppm</p> <p style="text-align: right;">▼</p> <p style="text-align: center;">MAX.SPAN</p> </div> </li> </ol> <ol style="list-style-type: none"> <li>Close the regulator.</li> <li>Unscrew the regulator.</li> <li>Remove the calibration cup.</li> <li>The instrument continues to the <b>START</b> item in the <b>A-CAL</b> menu.</li> <li>Press and release <b>POWER/MODE</b> to enter Measuring Mode.</li> </ol>	<ol style="list-style-type: none"> <li>The instrument indicates that the calibration failed.           <div data-bbox="1208 424 1386 575" style="border: 1px solid black; padding: 5px; margin: 10px 0;"> <p style="text-align: center;">H2S </p> <p style="text-align: center;">FAIL </p> <p style="text-align: right;">ppm</p> <p style="text-align: center;">E-CAL</p> </div> </li> </ol> <ol style="list-style-type: none"> <li>Close the regulator.</li> <li>Unscrew the regulator.</li> <li>Remove the calibration cup.</li> <li>Press and release <b>POWER/MODE</b> to return to the calibration start screen in the <b>A-CAL</b> menu.</li> <li>See "Troubleshooting" on page 67.</li> </ol>

## Setting the Calibration Values in CAL--P

1. While in User Mode, press AIR to scroll to **GAS CAL**.



2. Press and release POWER/MODE. The **AIR** item appears.
3. Use AIR to scroll to the **A-CAL** item (**E-CAL** if **E-CAL** in User Mode is set to **ON**).

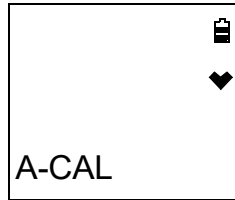

4. Press and release POWER/MODE. The Auto Cal screen appears.

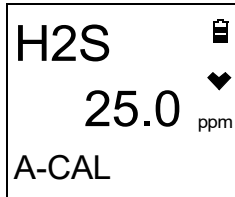

5. Use AIR to scroll to **CAL--P**.

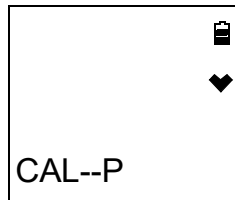

6. Press and release POWER/MODE. The gas name displays.

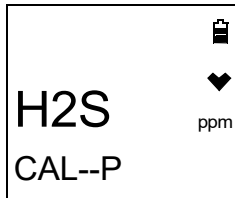

7. Press and release POWER/MODE. The calibration value begins to flash.

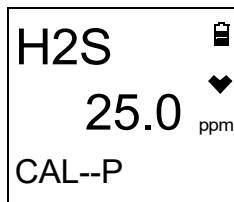

8. Use AIR to adjust the calibration gas value. The calibration gas value in the instrument must match the value listed on the calibration gas cylinder you are using.
9. Press and release POWER/MODE to save the change. The calibration gas value stops flashing and the unit returns to the gas name screen.
10. Use AIR to scroll to **ESCAPE**.
11. Press and release POWER/MODE to return to the **CAL--P** item in the **A-CAL** menu.
12. Press AIR to scroll to **ESCAPE**.
13. Press and release POWER/MODE to return to the **A-CAL** item in the **GAS CAL** menu.
14. See “Exiting the GAS CAL Menu” on page 52 to return to User Mode.

### Exiting the GAS CAL Menu

1. While in the **GAS CAL** menu, press AIR to scroll to **ESCAPE**.
2. Press and release POWER/MODE to return to the **GAS CAL** item in User Mode.
3. See “Entering Measuring Mode (START)” on page 66 to enter Measuring Mode.

---

## Setting Calibration Parameters (CAL SET)

The **CAL SET** menu has 4 items: **CAL.RMDR**, **CAL.INT**, **CAL.EXPD**, and **ESCAPE**.

1. While in User Mode, press AIR to scroll to **CAL SET**.

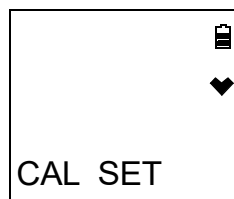

2. Press and release POWER/MODE. The **CAL.RMDR** item appears.

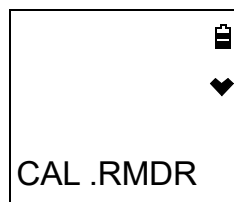

### **CAL.RMDR**

**ON (factory setting):** The GasWatch 3 gives an indication at start up if it is due for calibration. The type of indication depends on the **CAL.EXPD** setting (see pg.53).

**OFF:** The GasWatch 3 does not give an indication at start up if it is due for calibration.

1. After entering the **CAL SET** menu, press AIR to scroll to **CAL.RMDR**.

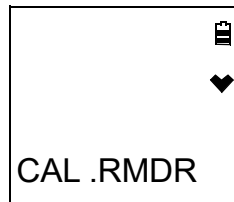

2. Press and release POWER/MODE. The current setting flashes.
3. Use AIR to display the desired setting.
4. Press and release POWER/MODE to save the setting and return to the **CAL.RMDR** item in the **CAL SET** menu.
5. See “Exiting the CAL SET Menu” on page 54 to return to User Mode.

## **CAL.INT**

This setting defines the amount of time between calibrations and can be set in 1 day increments. The minimum setting is **1** day and the maximum setting is **1000** days. The factory setting is **90** days.

1. After entering the **CAL SET** menu, press AIR to scroll to **CAL.INT**.

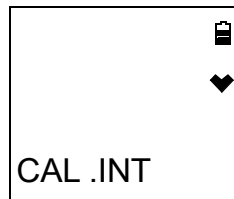

2. Press and release POWER/MODE. The current setting flashes.
3. Use AIR to display the desired setting.
4. Press and release POWER/MODE to save the setting and return to the **CAL.INT** item in the **CAL SET** menu.
5. See “Exiting the CAL SET Menu” on page 54 to return to User Mode.

## **CAL.EXPD**

This item defines what indication is given during start up when calibration is due and **CAL.RMDR** is set to **ON** (factory setting).

**CONFIRM** (factory setting): The GasWatch 3 gives an indication at start up if calibration is past due. Press and release AIR to continue without calibrating or press and release POWER/MODE to enter User Mode and perform a calibration.

**CANT.USE**: The GasWatch 3 gives an indication at start up that calibration is past due. Press and release POWER/MODE to enter User Mode and perform a calibration. Pressing AIR has no effect. A successful calibration must be performed in order to use the instrument.

**NONE**: The GasWatch 3 gives an indication at startup that calibration is past due. It is not necessary to acknowledge the indication. If desired, press POWER/MODE to enter User Mode and perform a calibration. The warm-up sequence continues on its own.

1. After entering the **CAL SET** menu, press AIR to scroll to **CAL.EXPD**.

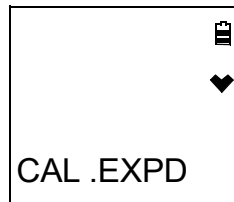

2. Press and release POWER/MODE. The current setting flashes.
3. Use AIR to display the desired setting.
4. Press and release POWER/MODE to save the setting and return to the **CAL.EXPD** item in the **CAL SET** menu.
5. See “Exiting the CAL SET Menu” on page 54 to return to User Mode.

### Exiting the **CAL SET** Menu

1. While in the **CAL SET** menu, press AIR to scroll to **ESCAPE**.
2. Press and release POWER/MODE to return to the **CAL SET** item in User Mode.
3. See “Entering Measuring Mode (START)” on page 66 to enter Measuring Mode.

---

## Setting Bump Test Parameters (**BUMP.SET**)

The **BUMP.SET** menu has 5 items: **SETTING**, **BP.RMDR**, **BP.INT**, **BP.EXPD**, and **ESCAPE**.

1. While in User Mode, press AIR to scroll to **BUMP.SET**.

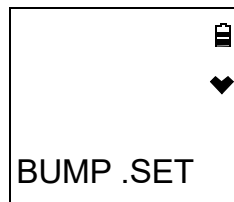

2. Press and release POWER/MODE. The **SETTING** item appears.

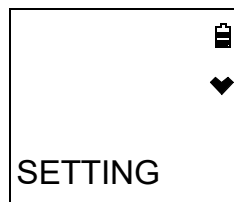

## SETTING

The **SETTING** menu has 5 items: **GAS.TIME**, **CHECK**, **CAL.TIME**, **A-CAL**, and **ESCAPE**.

1. After entering the **BUMP.SET** menu, press **AIR** to scroll to **SETTING**.

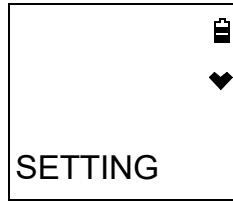

2. Press and release **POWER/MODE**. The **GAS.TIME** item appears.

### **GAS.TIME**

The **GAS.TIME** is the amount of time that the instrument is exposed to gas during a bump test. The available choices are **30** seconds (factory setting), **45** seconds, **60** seconds, and **90** seconds.

1. After entering the **SETTING** menu, press **AIR** to scroll to **GAS.TIME**.

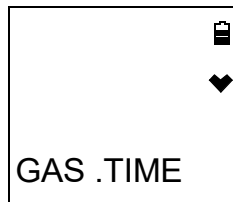

2. Press and release **POWER/MODE**. The current setting flashes.
3. Use **AIR** to display the desired setting.
4. Press and release **POWER/MODE** to save the setting and return to the **GAS TIME** item in the **SETTING** menu.
5. See “Exiting the SETTING Menu” on page 56 to return to **BUMP.SET** menu.

### **CHECK**

**CHECK** is the bump test tolerance value and is represented as a percentage of the calibration gas concentration. It is the percentage that the bump test reading can differ from the auto calibration value and still be considered a passed bump test. If the bump test reading differs more, the bump test fails. The available values are **10%**, **20%**, **30%**, **40%**, and **50%** (factory setting).

1. After entering the **SETTING** menu, press **AIR** to scroll to **CHECK**.

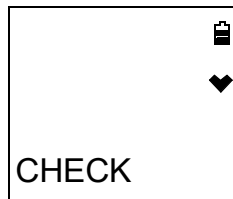

2. Press and release **POWER/MODE**. The current setting flashes.
3. Use **AIR** to display the desired setting.

4. Press and release POWER/MODE to save the setting and return to the **CHECK** item in the **SETTING** menu.
5. See “Exiting the SETTING Menu” on page 56 to return to **BUMP.SET** menu.

### **CAL.TIME**

The **CAL.TIME** is the total time the instrument is exposed to calibration gas if **A-CAL** is set to **ON** and a bump test fails. The bump test time is deducted from the calibration time. For example, if the **CAL.TIME** is set to 90 seconds and the **GAS.TIME** is set to 30 seconds, if the bump test fails, the GasWatch 3 is only exposed to gas for an additional 60 seconds. The available values are **90** seconds (factory setting), and **120** seconds.

1. After entering the **SETTING** menu, press AIR to scroll to **CAL.TIME**.

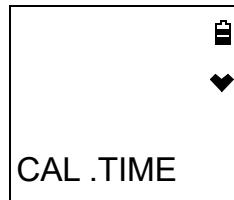

2. Press and release POWER/MODE. The current setting flashes.
3. Use AIR to display the desired setting.
4. Press and release POWER/MODE to save the setting and return to the **CAL.TIME** item in the **SETTING** menu.
5. See “Exiting the SETTING Menu” on page 56 to return to **BUMP.SET** menu.

### **A-CAL**

**ON** (factory setting): If a bump test fails, the unit automatically begins a calibration.

**OFF**: If a bump test fails, the unit does not automatically begin a calibration.

1. After entering the **SETTING** menu, press AIR to scroll to **A-CAL**.

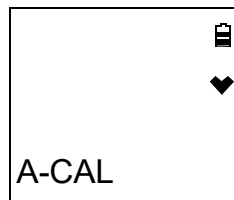

2. Press and release POWER/MODE. The current setting flashes.
3. Use AIR to display the desired setting.
4. Press and release POWER/MODE to save the setting and return to the **A-CAL** item in the **SETTING** menu.
5. See “Exiting the SETTING Menu” on page 56 to return to **BUMP.SET** menu.

### **Exiting the SETTING Menu**

1. While in the **SETTING** menu, press AIR to scroll to **ESCAPE**.
2. Press and release POWER/MODE to return to the **SETTING** item in the **BUMP.SET** menu.
3. See “Exiting the BUMP.SET Menu” on page 58 to return to User Mode.



## BP.RMDR

**ON:** The GasWatch 3 gives an indication at start up if it is due for bump testing. The type of indication depends on the **BP.EXPD** setting (see pg.57). If the instrument is not due for bump testing, a check mark appears in the lower left corner of the LCD.

**OFF (factory setting):** The GasWatch 3 does not give an indication at start up if it is due for bump testing.

1. After entering the **BUMP.SET** menu, press AIR to scroll to **BP.RMDR**.

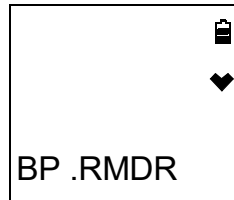

2. Press and release POWER/MODE. The current setting flashes.
3. Use AIR to display the desired setting.
4. Press and release POWER/MODE to save the setting and return to the **BP.RMDR** item in the **BUMP.SET** menu.
5. See “Exiting the BUMP.SET Menu” on page 58 to return to User Mode.

## BP.INT

This setting defines the amount of time between bump tests and can be set in 1 day increments. The minimum setting is **0** days and the maximum setting is **30** days (factory setting).

1. After entering the **BUMP.SET** menu, press AIR to scroll to **BP.INT**.

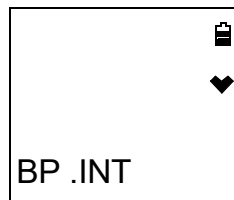

2. Press and release POWER/MODE. The current setting flashes.
3. Use AIR to display the desired setting.
4. Press and release POWER/MODE to save the setting and return to the **BP.INT** item in the **BUMP.SET** menu.
5. See “Exiting the BUMP.SET Menu” on page 58 to return to User Mode.

## BP.EXPD

This item defines what indication is given during start up when a bump test is due and **BP.RMDR** is set to **ON** (factory setting is **OFF**).

**CONFIRM (factory setting):** The GasWatch 3 gives an indication at start up if a bump test is past due. Press and release AIR to continue without bump testing or press and release POWER/MODE to enter User Mode and perform a bump test.

**CANT.USE:** The GasWatch 3 gives an indication at start up that a bump test is past due. Press and release POWER/MODE to enter User Mode and perform a bump test. Pressing AIR has no effect. A successful bump test must be performed in order to use the instrument.

**NONE:** The GasWatch 3 gives an indication at startup that a bump test is past due. It is not necessary to acknowledge the indication. If desired, press POWER/MODE to enter User Mode and perform a bump test. The warm-up sequence continues on its own.

1. After entering the **BUMP.SET** menu, press AIR to scroll to **BP.EXPD**.



2. Press and release POWER/MODE. The current setting flashes.
3. Use AIR to display the desired setting.
4. Press and release POWER/MODE to save the setting and return to the **BP.EXPD** item in the **BUMP.SET** menu.
5. See “Exiting the BUMP.SET Menu” on page 58 to return to User Mode.

### Exiting the BUMP.SET Menu

1. While in the **BUMP.SET** menu, press AIR to scroll to **ESCAPE**.
2. Press and release POWER/MODE to return to the **BUMP.SET** item in User Mode.
3. See “Entering Measuring Mode (START)” on page 66 to enter Measuring Mode.

---

## Alarm Settings (ALARM--P)

The **ALARM--P** menu has 3 items: **ALARM--P**, **DEF.ALMP**, and **ESCAPE**.

1. While in User Mode, press AIR to scroll to **ALARM--P**.

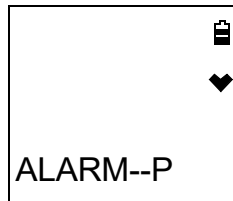

2. Press and release POWER/MODE. The first screen displays.



## Setting the Alarm Points

1. After entering the **ALARM-P** menu, press AIR to scroll to the gas name.

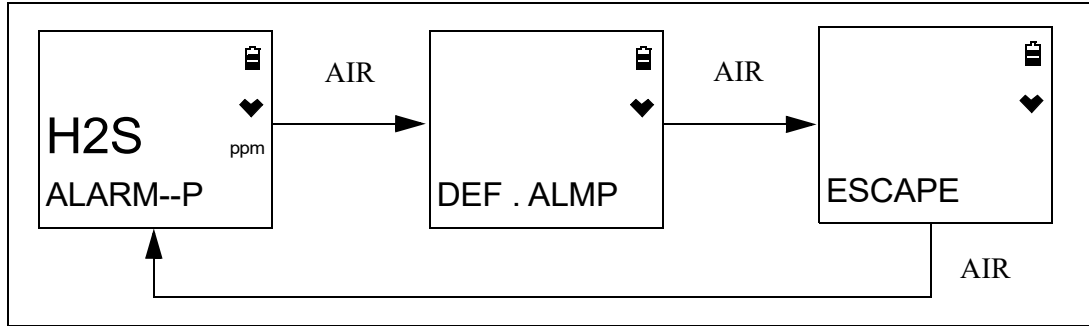

2. Press and release **POWER/MODE**.
3. The Warning setpoint flashes.

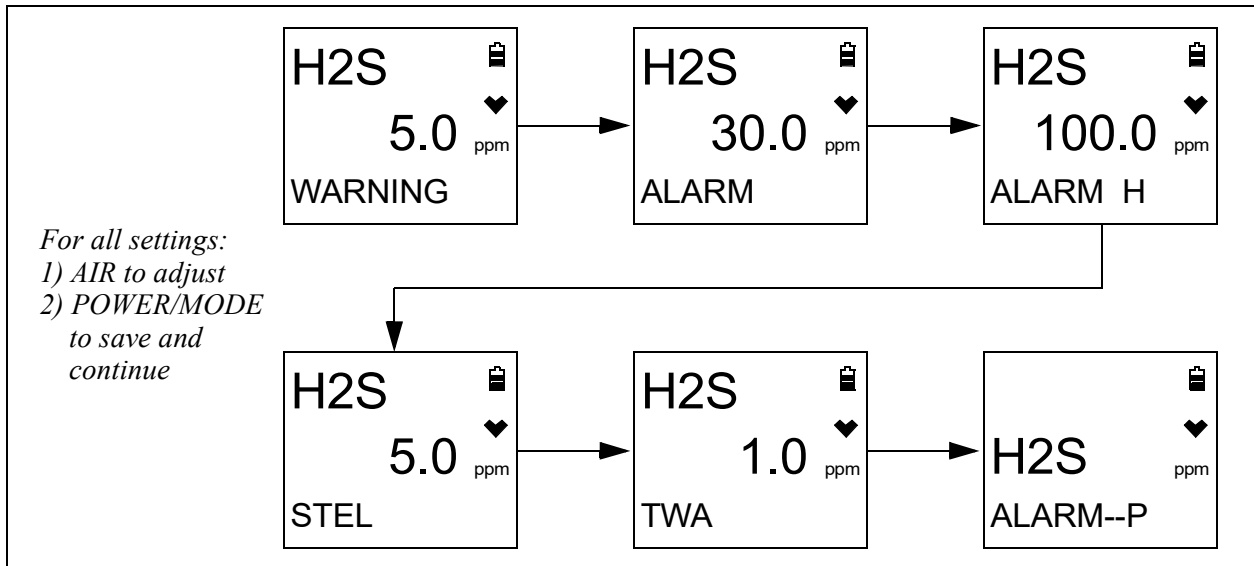

4. Use AIR to adjust the Warning setpoint. The alarm setpoint limitations are:  
 $1.0 \text{ ppm} \leq \text{WARNING} \leq \text{ALARM} \leq \text{ALARM H} \leq 200.0 \text{ ppm}$ .
5. Press and release **POWER/MODE** to save the setting.
6. Repeat Step 4 and Step 5 for the Alarm, Alarm H, STEL and TWA settings.
7. The instrument returns to the channel selection screen.
8. See “ESCAPE” on page 60 to return to User Mode.

## Defaulting the Alarm Points

Defaulting the alarm points defaults them back to factory settings as outlined in Table 1 on page 7 or to the settings saved in the **SAVE-AP** item in Gas Select Mode if you performed a **SAVE-AP** operation.

1. After entering the **ALARM-P** menu, press AIR to scroll to **DEF.ALMP**.



2. Press POWER/MODE to enter the **DEF.ALMP** item.
3. Press POWER/MODE to perform an alarm default. Press AIR to return to the **DEF.ALMP** item in the **ALARM-P** menu.
4. The instrument asks if you're sure you want to default the alarm points.
5. Press POWER/MODE to default the alarm points. Press AIR to return to the **DEF.ALMP** item in the **ALARM-P** menu.
6. See "ESCAPE" on page 60 to return to User Mode.

## ESCAPE

1. While in the **ALARM-P** menu, press AIR to scroll to **ESCAPE**.
2. Press and release POWER/MODE to return to the **ALARM--P** item in User Mode.
3. See "Entering Measuring Mode (START)" on page 66 to enter Measuring Mode.

---

## Updating the Lunch Break Setting (LUNCH)

**OFF (factory setting):** The GasWatch 3 automatically starts new TWA and PEAK reading collection and resets the time in operation at startup.

**ON:** The Lunch Break Screen displays during startup. From this screen, you can choose to continue accumulating TWA and PEAK readings and the time in operation from the last time the GasWatch 3 was used or start collecting new readings and reset the time in operation.

1. While in User Mode, press AIR to scroll to **LUNCH**.

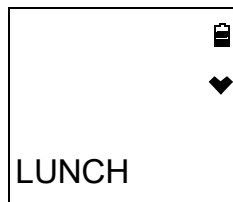

2. Press and release POWER/MODE. The current setting flashes.
3. Use AIR to display the desired setting.
4. Press and release POWER/MODE to save the setting and return to the **LUNCH** item in User Mode.
5. See "Entering Measuring Mode (START)" on page 66 to enter Measuring Mode.

---

## Setting the Confirmation Beep and Non-Compliance Indicator (BEEP)

The **BEEP** menu has 3 items: **BEEP.SEL**, **BEEP.INT**, and **ESCAPE**.

1. While in User Mode, press AIR to scroll to **BEEP**.

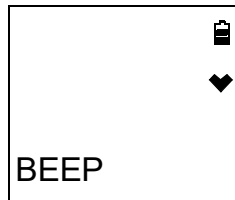

2. Press and release POWER/MODE. The **BEEP.SEL** item appears.



### **BEEP.SEL**

**BEEP.SEL** defines what kind of confirmation or non-compliance indication you want to occur in Measuring Mode. The available choices are:

**OFF** (factory setting): The GasWatch 3 does not provide a confirmation alert or non-compliance indicator.

**LED**: The GasWatch 3's LEDs double flash as often as defined by the **BEEP.INT** parameter to verify that the instrument is operating.

**BUZZER**: The GasWatch 3's buzzer double beeps as often as defined by the **BEEP.INT** parameter to verify that the instrument is operating.

**LED+BUZ**: The GasWatch 3's LEDs double flash and the buzzer double beeps as often as defined by the **BEEP.INT** parameter to verify that the instrument is operating.

**BMP/CAL**: If a bump test or a calibration is due and if **BP.EXPD** or **CAL.EXPD** is set to **CONFIRM** (factory setting) or **NONE**, the GasWatch 3's LEDs double flash as often as defined by the **BEEP.INT** parameter to indicate a non-compliance. Once a bump test or calibration (depending on which is due) is done, the LEDs stop flashing.

1. While in the **BEEP** menu, press AIR to scroll to **BEEP.SEL**.

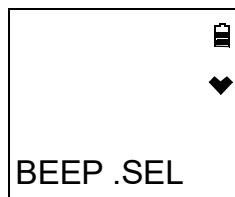

2. Press and release POWER/MODE. The current setting flashes.
3. Use AIR to display the desired setting.

4. Press and release POWER/MODE to save the setting and return to the **BEEP.SEL** item in the **BEEP** menu.
5. See “ESCAPE” on page 62 to return to User Mode.

## **BEEP.INT**

The **BEEP.INT** parameter defines how often the confirmation alert or non-compliance indicator selected in **BEEP.SEL** occurs. This setting only applies if the **BEEP.SEL** parameter is set to something other than **OFF** (factory setting). The available choices are **0.5** minutes and **1-99** minutes in 1 minute increments. The factory setting is **5** minutes.

1. While in the **BEEP** menu, press AIR to scroll to **BEEP.INT**.

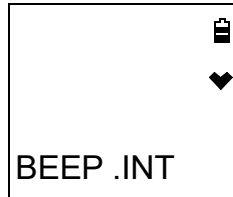

2. Press and release POWER/MODE. The current setting flashes.
3. Use AIR to display the desired setting.
4. Press and release POWER/MODE to save the setting and return to the **BEEP.INT** item in the **BEEP** menu.
5. See “ESCAPE” on page 62 to return to User Mode.

## **ESCAPE**

1. While in the **BEEP** menu, press AIR to scroll to **ESCAPE**.
2. Press and release POWER/MODE to return to the **BEEP** item in User Mode.
3. See “Entering Measuring Mode (START)” on page 66 to enter Measuring Mode.

---

## **Updating the Backlight Time (BL TIME)**

This setting defines how long the LCD backlight stays on when you press any button. The minimum setting is **OFF**; the maximum setting is **255** seconds. The factory setting is **30** seconds.

1. While in User Mode, press AIR to scroll to **BL TIME**.

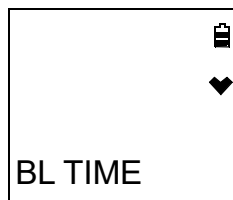

2. Press and release POWER/MODE. The current setting flashes.
3. Use AIR to display the desired setting.
4. Press and release POWER/MODE to save the setting and return to the **BL TIME** item in User Mode.
5. See “Entering Measuring Mode (START)” on page 66 to enter Measuring Mode.

---

## Turning the Key Tone On/Off (KEY.TONE)

**ON** (factory setting): The instrument beeps when a button is pressed.

**OFF**: The instrument does not beep when a button is pressed.

1. While in User Mode, press AIR to scroll to **KEY.TONE**.

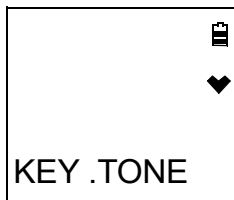

2. Press and release POWER/MODE. The current setting flashes.
3. Use AIR to display the desired setting.
4. Press and release POWER/MODE to save the setting and return to the **KEY.TONE** item in User Mode.
5. See “Entering Measuring Mode (START)” on page 66 to enter Measuring Mode.

---

## Display Mode Items (DISP.SET)

**OFF**: **USER ID**, **STN ID**, and **BUZZ.VOL** screens do not appear in Display Mode.

**ON** (factory setting): **BUZZ.VOL** screen appears in Display Mode. **USER ID** and **STN ID** screens appear in Display Mode if **ID DISP** in Maintenance Mode is also set to **ON** (factory setting is **OFF**).

1. While in User Mode, press AIR to scroll to **DISP.SET**.



2. Press and release POWER/MODE. The current setting flashes.
3. Use AIR to display the desired setting.
4. Press and release POWER/MODE to save the setting and return to the **DISP.SET** item in User Mode.
5. See “Entering Measuring Mode (START)” on page 66 to enter Measuring Mode.

---

## Zero Suppression (ZERO.SUP)

This item only appears if **ZSUP.DSP** is set to **ON** in Maintenance Mode (factory setting is **OFF**).

The **ZERO.SUP** setting is not intended for field adjustment. The default setting is **ON**. The suppression value is 2 ppm.

---

## Zero Follower (ZERO.FLW)

This item only appears if **ZFLW.DSP** is set to **ON** in Maintenance Mode (factory setting is **OFF**).

The **ZERO.FLW** setting is not intended for field adjustment. The default setting is **ON**.

---

## Turning Easy Calibration On/Off (E-CAL)

**OFF (factory setting):** Auto Calibration (**A-CAL**) item appears in **GAS CAL** menu instead of Easy Calibration (**E-CAL**).

**XX seconds:** Easy Calibration (**E-CAL**) item appears in **GAS CAL** menu instead of Auto Calibration (**A-CAL**). During a calibration, the instrument counts down from the number of seconds you select.

1. While in User Mode, press AIR to scroll to **E-CAL**.

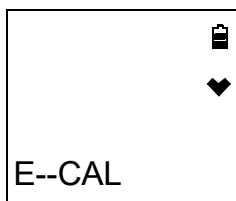

2. Press and release POWER/MODE. The current setting flashes.
  3. Use AIR to display the desired setting.
  4. Press and release POWER/MODE to save the setting and return to the **E-CAL** item in User Mode.
  5. See “Entering Measuring Mode (START)” on page 66 to enter Measuring Mode.
- 

## Setting the Date/Time (DATE)

1. While in User Mode, place the cursor next to **DATE**.

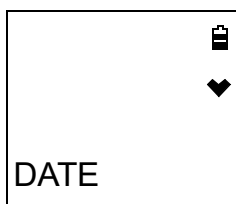

2. Press and release POWER/MODE. The date and time display with the year flashing.

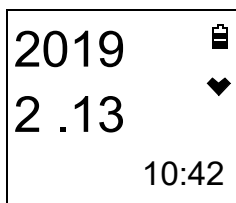

3. Use AIR to display the desired year.
4. Press and release POWER/MODE to save the setting. The month setting flashes.



5. Repeat Step 3 and Step 4 to enter the month, day, hours, and minutes settings. The date and time are saved and the instrument returns to the **DATE** item in User Mode.
6. See “Entering Measuring Mode (START)” on page 66 to enter Measuring Mode.

---

## Turning the Password On/Off (PASS-W)

**ON:** The GasWatch 3 prompts you for a password when you enter User Mode. The factory-set password is **0405** but it can be changed.

**OFF (factory setting):** No password is required to enter User Mode.

1. While in User Mode, press AIR to scroll to **PASS-W**.

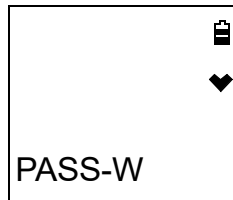

2. Press and release POWER/MODE. The current setting flashes.
3. Use AIR to display the desired setting.
4. If you selected **OFF**, press and release POWER/MODE to save the setting and return to the **PASS-W** item in User Mode.

If you selected **ON**, continue with Step 5.

5. Press and release POWER/MODE. The Set Password Screen appears. The current password appears and the first digit flashes.

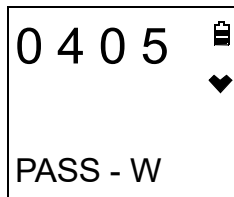

6. Use AIR to display a number from 0 to 9.
7. Press and release POWER/MODE to enter the selection and advance to the next number. To go back a number, press and hold AIR and POWER/MODE for a few seconds.
8. Repeat Step 6 and Step 7 to select the remaining numbers. When you press and release POWER/MODE to enter the last number, the password is saved and the instrument returns to the **PASS-W** item in User Mode.
9. See “Entering Measuring Mode (START)” on page 66 to enter Measuring Mode.

---

## Viewing the ROM/SUM (ROM/SUM)

The **ROM/SUM** screen shows the instrument's firmware version and firmware checksum.

1. While in User Mode, press AIR to scroll to **ROM/SUM**.

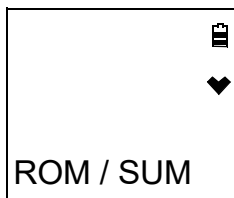

2. Press and release POWER/MODE. The screen cycles through the main board's ROM/SUM and the sensor board's ROM/SUM. The ROM is the top value and the SUM is the bottom value.

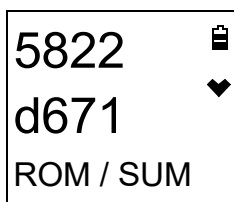

3. Press and release POWER/MODE to return to the **ROM/SUM** item in User Mode.
4. See "Entering Measuring Mode (START)" on page 66 to enter Measuring Mode.

---

## Entering Measuring Mode (START)

1. While in User Mode, press AIR to scroll to **START**.

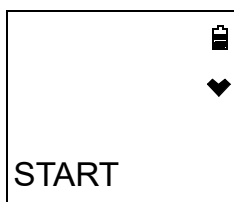

2. Press and release POWER/MODE. The instrument begins its warmup sequence.

# Chapter 6: Maintenance

## Overview

This chapter describes troubleshooting procedures for the GasWatch 3. It also includes procedures for replacing the battery and replacing various consumable parts.

---

**WARNING:** *RKI Instruments recommends that service, calibration, and repair of RKI gas detectors be performed by personnel properly trained for this work. Replacing the sensor and other parts with original equipment does not affect the intrinsic safety of the instrument.*

---

---

**AVERTISSEMENT:** *RKI Instruments recommande que le service, l'étalonnage et la réparation des détecteurs de gaz RKI soient effectués par du personnel dûment formé à ces travaux. Le remplacement du capteur et d'autres pièces par l'équipement d'origine n'affecte pas la sécurité intrinsèque de l'instrument.*

---

## Troubleshooting

The troubleshooting table describes error messages, symptoms, probable causes, and recommended action for problems you may encounter with the GasWatch 3.

**Table 9: Troubleshooting the GasWatch 3**

Symptoms	Probable Causes	Recommended Action
<ul style="list-style-type: none"><li>The LCD is blank.</li></ul>	<ul style="list-style-type: none"><li>The unit got turned off.</li><li>The battery is inserted backwards.</li><li>The battery needs to be replaced.</li><li>The battery cover may not be completely closed.</li></ul>	<ol style="list-style-type: none"><li>To turn on the unit, press and briefly hold POWER/MODE.</li><li>Reinstall the battery in the correct orientation.</li><li>Replace the battery.</li><li>Be sure the battery cover is completely closed and that the screw is tight.</li><li>If the difficulties continue, contact RKI Instruments, Inc. for further instruction.</li></ol>
<ul style="list-style-type: none"><li>The LCD shows an abnormally high reading but other gas detection instruments do not.</li></ul>	<ul style="list-style-type: none"><li>Humidity filter needs to be replaced.</li><li>The GasWatch 3 needs to be recalibrated.</li><li>The sensor needs replacement.</li></ul>	<ol style="list-style-type: none"><li>Replace the humidity filter.</li><li>Recalibrate the unit.</li><li>If the difficulties continue, replace the sensor and calibrate.</li><li>If the difficulties continue, contact RKI Instruments, Inc. for further instruction.</li></ol>

**Table 9: Troubleshooting the GasWatch 3**

Symptoms	Probable Causes	Recommended Action
<ul style="list-style-type: none"> <li>• Calibration fails.</li> </ul>	<ul style="list-style-type: none"> <li>• The calibration value does not match the cylinder gas concentration.</li> <li>• The sample gas is not reaching the sensor because of a bad connection.</li> <li>• The calibration cylinder is out of gas or is outdated.</li> <li>• The sensor needs replacement.</li> </ul>	<ol style="list-style-type: none"> <li>1. Make sure the GasWatch 3 has been properly set up for calibration.</li> <li>2. Check all calibration tubing for leaks or for any bad connections.</li> <li>3. Verify that the calibration cylinder contains an adequate supply of fresh test sample.</li> <li>4. If the fail condition continues, replace the sensor.</li> <li>5. If the difficulties continue, contact RKI Instruments, Inc. for further instruction.</li> </ol>
<ul style="list-style-type: none"> <li>• Heart symbol at the top of the screen becomes steadily on or disappears.</li> </ul>	<ul style="list-style-type: none"> <li>• A microprocessor error has occurred.</li> </ul>	<ul style="list-style-type: none"> <li>• Contact RKI Instruments, Inc. for further instruction.</li> </ul>

## Replacing the Battery

**WARNING:** *To prevent ignition of a hazardous atmosphere, battery must only be changed in an area known to be nonhazardous.*

**AVERTISSEMENT:** *Pour éviter l'inflammation d'une atmosphère dangereuse, la batterie ne doit être remplacée que dans une zone non dangereuse.*

Replace the battery when the battery icon flashes and its lowest battery level indication bar disappears.

1. Make sure the GasWatch 3 is off.
2. For alligator clip versions, pry the base clip off so that it swings away from the instrument.

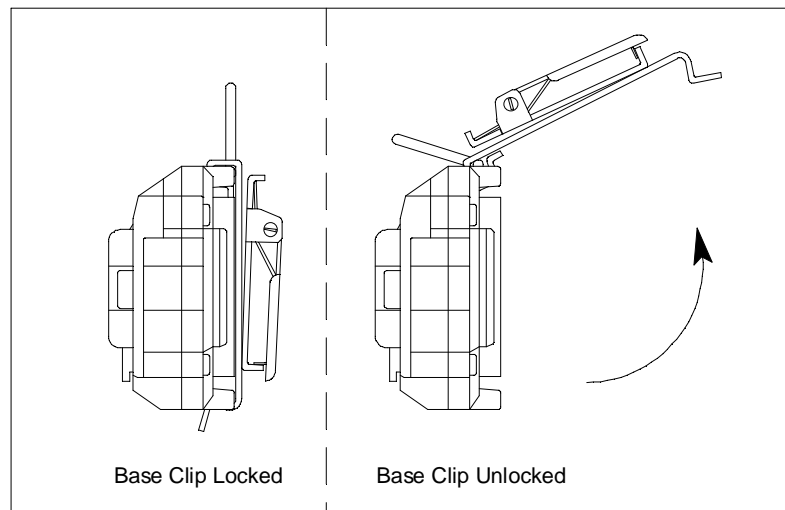

**Figure 8: Releasing the Alligator Clip**

3. Use a small Phillips screwdriver to unscrew the battery retainer's screw.

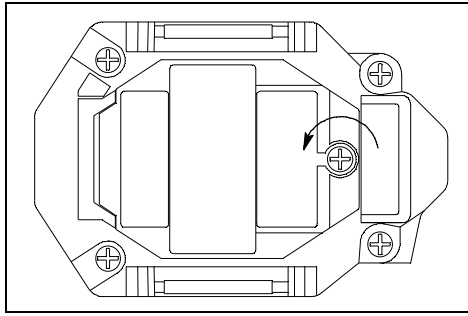

**Figure 9: Removing the Battery Retainer**

4. Remove the battery retainer.
5. Remove the old battery.
6. Install the new CR2450 button cell battery and reinstall the battery retainer and screw.

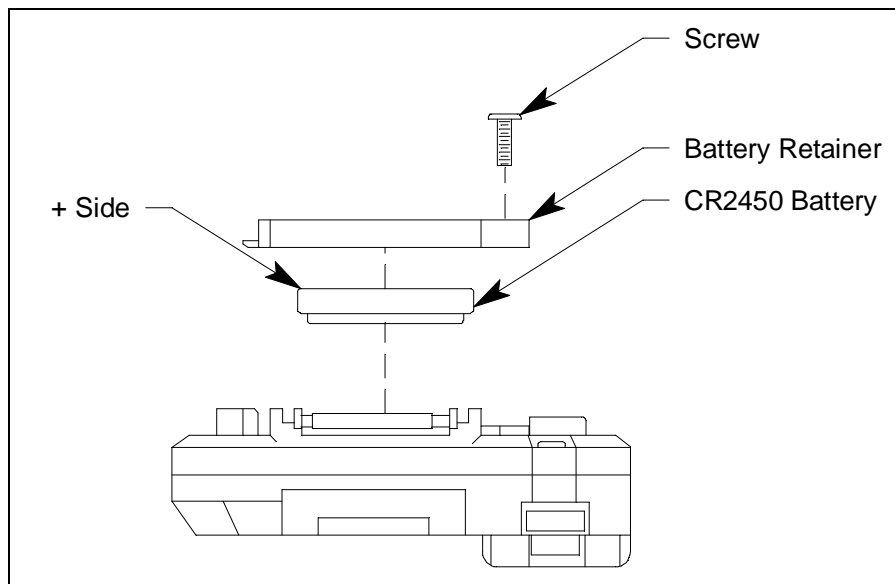

**Figure 10: Installing a New Battery**

7. If the instrument has been without batteries for more than 5 minutes, the date and time are reset and need to be set again. When the new batteries are installed, the instrument automatically turns on and displays the Date/Time Screen. Set the date and time as described on pg.64. Once the date and time are set, the instrument begins its warmup sequence. If you do not set the date and time within 30 seconds, the instrument automatically begins its warmup sequence.

---

## Replacing the Humidity Filter

1. Verify that the GasWatch 3 is off.
2. Use a small Phillips screwdriver to unscrew the sensor retainer's screw.
3. Remove the sensor retainer.
4. The white hydrophobic filter and the sensor gasket should stay on the sensor.
5. Remove the white hydrophobic filter.
6. Remove the white humidity filter from the center of the sensor gasket.

7. Install the new humidity filter. It should be seated and recessed in the center of the sensor gasket.

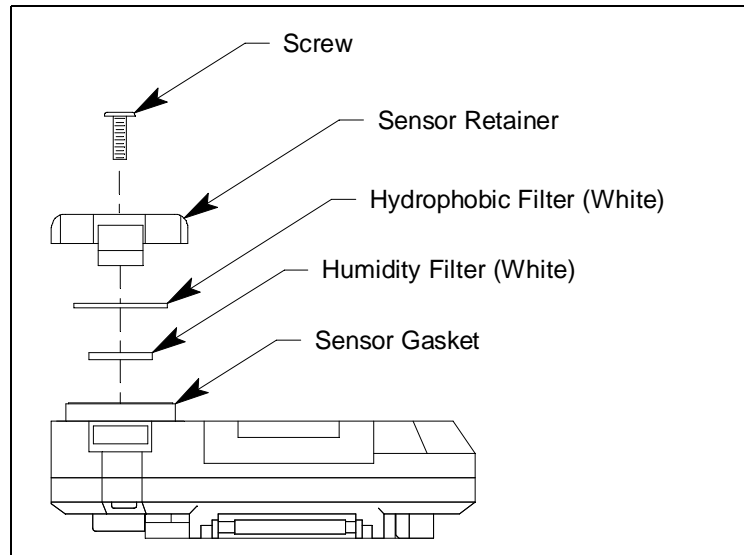

**Figure 11: Replacing the Humidity Filter**

8. Reinstall the white hydrophobic filter. It should be seated and recessed in the sensor gasket and should not overlap the edge of the sensor gasket.
9. Reinstall the sensor retainer and tighten its screw.

---

## Replacing the Hydrophobic Filter

1. Verify that the GasWatch 3 is off.
2. Use a small Phillips screwdriver to unscrew the sensor retainer's screw.
3. Remove the sensor retainer.
4. The hydrophobic filter and the sensor gasket should stay on the sensor.
5. Remove the old hydrophobic filter.

6. Install the new hydrophobic filter. It should be seated and recessed in the sensor gasket and should not overlap the edge of the sensor gasket.

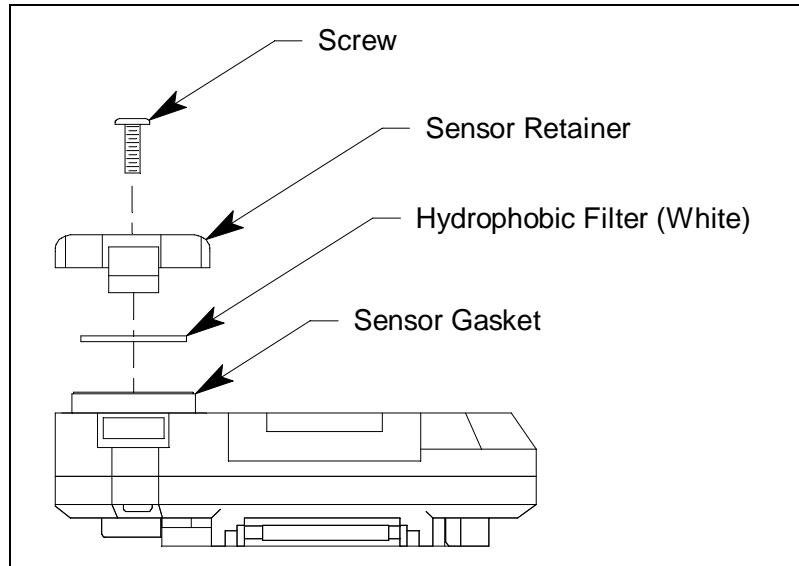

**Figure 12: Replacing the Hydrophobic Filter**

7. Reinstall the sensor retainer and tighten its screw.

---

## Replacing the Sensor

1. Verify that the GasWatch 3 is off.
2. Use a small Phillips screwdriver to unscrew the sensor retainer's screw.
3. Remove the sensor retainer.
4. Remove the sensor gasket and filters. The filters may fall out. The sensor is exposed.

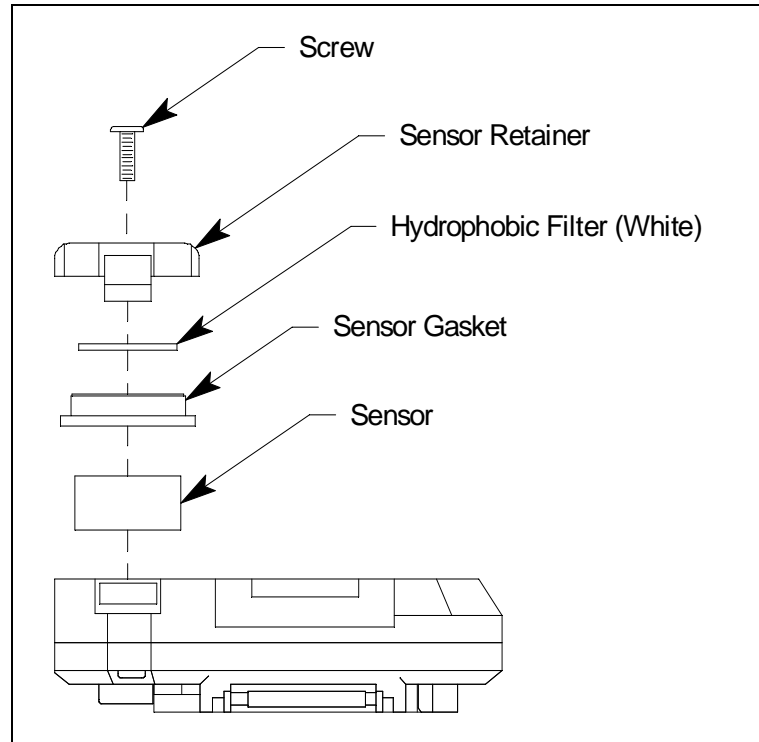

**Figure 13: Replacing the Sensor**

5. Remove the old sensor from its socket.
6. Carefully insert the replacement sensor. Be sure that the new sensor's orientation slots are aligned correctly. Do not force the sensor into its slot.
7. Reinstall the sensor gasket. Be sure to orient it as shown in Figure 13 above.
8. Reinstall the humidity filter. It should be seated and recessed in the center of the sensor gasket.
9. Reinstall the hydrophobic filter. It should be seated and recessed in the sensor gasket and should not overlap the edge of the sensor gasket.
10. Reinstall the sensor retainer and tighten its screw.
11. Calibrate the new sensor as described on pg.43.



## Chapter 7: General Parts List

Table 10 lists part numbers for the GasWatch 3's replacement parts and accessories.

**Table 10: General Parts List**

Part Number	Description
06-1248RK-03	Calibration kit tubing, 3 foot length
07-0056	Sensor gasket
10-1088	Screw, for sensor retainer and battery retainer
13-0105RK	Watch band
13-0126	Alligator clip
13-0204RK	Pins for connecting watch band/alligator clip
21-1955	Sensor retainer
21-1956	Battery retainer
33-0175	Hydrophobic filter
33-7136	Humidity filter, 5 pack
47-5084RK	USB/IrDA adapter module, Legasic, for use with all premier portables (without USB cable)
47-5084RK-01	USB/IrDA adapter assembly, Legasic, for use with all premier portables (with module and USB cable)
47-5085RK	Cable, USB A to USB mini, 6 feet, for 47-5084RK USB/IrDA adapter module
49-1404RK	Battery, CR 2450 coin type
71-0511	Operator's Manual, GasWatch 3 for H <sub>2</sub> S (this document)
71-0514	Operator's Manual, GasWatch 3 Datalogging Program
71-0515	Operator's Manual, GasWatch 3 Setup Program
81-0076RK-01	Calibration cylinder, zero air, 34 liter steel
81-0076RK-03	Calibration cylinder, zero air, 103 liter
81-0151RK-02	Calibration cylinder, 25 ppm H <sub>2</sub> S in nitrogen, 58 liter
81-0151RK-04	Calibration cylinder, 25 ppm H <sub>2</sub> S in nitrogen, 34 liter aluminum
81-1050RK-25	Regulator, fixed flow, 0.25 LPM, with gauge and knob, for 17 liter and 34 liter steel cylinders (cylinders with external threads)
81-1051RK-25	Regulator, fixed flow, 0.25 LPM, with gauge and knob, for 34 liter aluminum, 58 liter, and 103 liter cylinders (cylinders with internal threads)
81-1194	Calibration cup
81-GW3HS	Calibration kit: 58 liter cylinder of 25 ppm H <sub>2</sub> S in N <sub>2</sub> , regulator, tubing, calibration cup, case

**Table 10: General Parts List (cont.)**

<b>Part Number</b>	<b>Description</b>
81-GW3HS-LV	Calibration kit: 34 liter aluminum cylinder of 25 ppm H <sub>2</sub> S in N <sub>2</sub> , regulator, tubing, calibration cup, case
ESR-A13i-H2S	Hydrogen sulfide (H <sub>2</sub> S) sensor

# Appendix A: Maintenance Mode

## Overview

This appendix describes the GasWatch 3 in Maintenance Mode. The GasWatch 3 is factory-set to suit most applications. Update settings in Maintenance Mode only if required for your specific application. Maintenance Mode items and their factory settings are listed in Table 11 below.

**Table 11: Maintenance Mode Menu Items**

Maintenance Mode Menu Item	Description	
GAS CAL (pg.78)	Perform an air adjust, perform a span adjustment, change the calibration values.	
	AIR      Perform a fresh air adjustment.	
	A-CAL or E-CAL depending on E-CAL User Mode setting	Perform a span adjustment and set the calibration gas concentration.
		A-CAL (or E-CAL)      Perform an automatic span adjustment.
		START      Begin the warmup sequence and enter Measuring Mode.
		CAL-P      Set the calibration gas concentration.
	ESCAPE      Return to the A-CAL item in the GAS CAL menu.	
ESCAPE      Return to the GAS CAL item in Maintenance Mode.		
GAS.TEST (pg.78)	Apply gas to test sensor response and observe alarm indications without an alarm event being recorded.	
SEN.DATE (pg.79)	View and/or set the replacement date for the sensor and the battery.	
BUMP (pg.80)	Perform a bump test.	
LATCH (pg.80)	<b>ON (factory setting):</b> The GasWatch 3 remains in alarm until the alarm condition passes and POWER/MODE is pressed. <b>OFF:</b> The GasWatch 3 automatically resets an alarm when the alarm condition passes.	
D.ZERO (pg.81)	<b>ON (factory setting):</b> You can manually perform a fresh air adjust in Measuring Mode by pressing AIR. <b>OFF:</b> You cannot manually perform a fresh air adjust in Measuring Mode by pressing AIR.	
A.ZERO (pg.81)	<b>ON:</b> The GasWatch 3 asks if you want to perform a fresh air adjustment at the end of the startup sequence. <b>OFF (factory setting):</b> The GasWatch 3 does not ask if you want to perform a fresh air adjustment at the end of the startup sequence.	
ID DISP (pg.82)	<b>ON:</b> User ID and Station ID screens appear in startup sequence. IDs can be changed in Display Mode if DISP.SET in User Mode is also set to ON. <b>OFF (factory setting):</b> User ID and Station ID screens do not appear in startup sequence. IDs cannot be changed in Display Mode.	

**Table 11: Maintenance Mode Menu Items**

<b>Maintenance Mode Menu Item</b>	<b>Description</b>
ZERO.SUP (pg.82)	<b>ON (factory setting):</b> Not intended for field adjustment. The suppression value is 2 ppm.
ZERO.FLW (pg.82)	<b>ON (factory setting):</b> Not intended for field adjustment.
ZSUP.DSP (pg.82)	<b>ON:</b> Zero suppression item appears in User Mode. <b>OFF (factory setting):</b> Zero suppression item does not appear in User Mode. (Zero suppression item is always available in Maintenance Mode)
ZFLW.DSP (pg.82)	<b>ON:</b> Zero follower item appears in User Mode. <b>OFF (factory setting):</b> Zero follower item does not appear in User Mode. (Zero follower item is always available in Maintenance Mode)
CYL.DISP (pg.83)	<b>ON:</b> <b>CYL SEL</b> item appears in <b>GAS CAL</b> . <b>OFF (factory setting):</b> <b>CYL SEL</b> item does not appear in <b>GAS CAL</b> . (RKI Instruments, Inc. does not recommend adjusting this setting.)
DATE (pg.83)	Set the current date and time.
PASS-W (pg.83)	<b>ON (factory setting):</b> Maintenance Mode is password-protected. Factory-set password is <b>3000</b> . <b>OFF:</b> Maintenance Mode is not password-protected.
ROM/SUM (pg.84)	View the firmware information for the GasWatch 3's sensor board and main board.
M.DEF (pg.85)	Set all parameters back to their RKI factory settings.
START (pg.85)	Press and release POWER/MODE to begin the warmup sequence and enter Measuring Mode.

## Entering Maintenance Mode

---

**WARNING:** *The GasWatch 3 is not in operation as a gas detector while in Maintenance Mode.*

---

1. Take the GasWatch 3 to a non-hazardous location and turn it off if it is on.
2. Press and hold AIR, then press and hold POWER/MODE. You will hear a beep after one second. Continue to hold the buttons down.
3. When you hear a second beep, release the buttons.

- The screen that appears depends on the setting of Maintenance Mode's **PASS-W** item. If **PASS-W** is set to **OFF**, continue with Step 8.

If **PASS-W** is set to **ON** (factory setting), continue with Step 5.

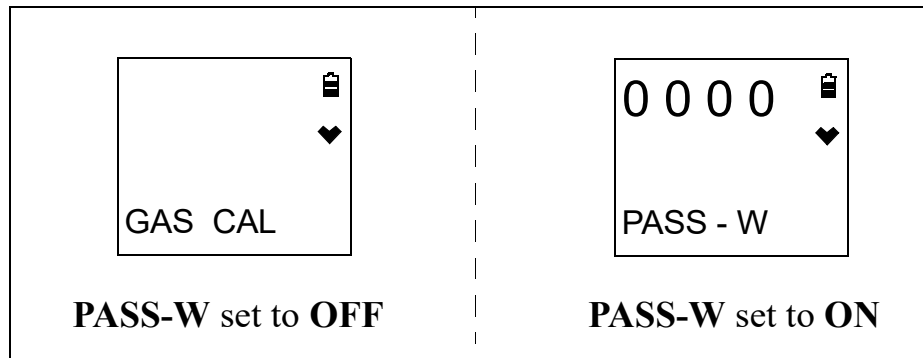

- If **PASS-W** is set to **ON** in Maintenance Mode, a password screen appears and the first digit is flashing. The factory-set password is **3000** but it can be changed.
- Use **AIR** to select each password number then press **POWER/MODE** to save it and move on to the next number. To go back a number, press and hold **AIR** and **POWER/MODE** for a few seconds. To reverse the direction of change (ie. from increasing to decreasing or vice versa):
  - Press and hold **AIR**.
  - Immediately press **POWER/MODE** and then release both buttons.
- Continue to Step 6.
- The **GAS CAL** item displays.

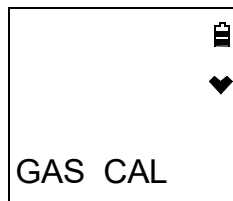

- Use **AIR** to move through the Maintenance Mode items.

---

## Tips for Using Maintenance Mode

- To scroll from one item to the next, press and release **AIR**. To reverse the scrolling direction:
  - Press and hold **AIR**.
  - Immediately press **POWER/MODE** and then release both buttons.
  - The scrolling direction returns to the original direction when you exit and reenter a menu.
- To skip an item when a question is asked, press and release **AIR**.
- To enter an item and to save any changes, press and release **POWER/MODE**.

- To change a flashing parameter, press and release AIR. To reverse the direction of change (ie. from increasing to decreasing or vice versa):
  - a. Press and hold AIR.
  - b. Immediately press POWER/MODE and then release both buttons.
- To exit an entered item without saving a change, press and hold AIR and POWER/MODE for a few seconds.

---

## Performing a Calibration (GAS CAL)

See pg.43 for a description of the GAS CAL item.

---

## Performing a Gas Test (GAS.TEST)

The GAS.TEST item allows you to apply gas to the instrument and see all alarm indications except for the buzzer indication. There is no buzzer indication in the GAS.TEST menu even though the buzzer sounds in the event of a real gas alarm condition while in Measuring Mode.

A gas test is not saved in logged data.

### **Preparing for a Gas Test**

To perform a gas test on the GasWatch 3, you need:

- A calibration gas cylinder. The concentrations should be above the alarm condition you want to check. Standard alarm points are listed on pg.7.
  - A 0.25 LPM fixed flow regulator
  - Non-absorbent tubing
  - Calibration cup
1. Install the calibration cup onto the GasWatch 3. The calibration cup has an indicated flow direction. Be sure the calibration cup is installed in the correct direction and that it is pushed on all the way.

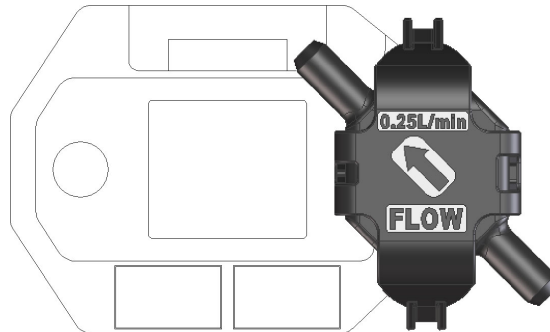

2. Use the tubing to connect the regulator to the inlet of the calibration cup.

## Performing a Gas Test

1. While in Maintenance Mode, press AIR to scroll to **GAS.TEST**.

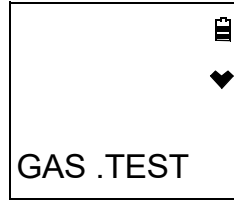

2. Press and release POWER/MODE. The current gas reading displays. The bottom of the LCD alternates between "GAS.TEST" and "BUZZ.OFF".

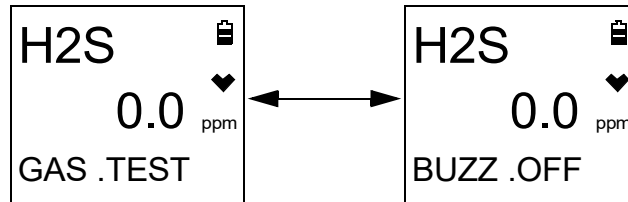

3. It is important to vent the regulator while installing it onto the cylinder. Venting the regulator during installation helps prevent air from getting into the cylinder and degrading the gas. Open the 0.25 LPM regulator by turning the knob counterclockwise and install it onto the cylinder.
4. The instrument initiates alarm indications except for the buzzer. There is no buzzer indication in the **GAS.TEST** menu even though the buzzer sounds in the event of a real gas alarm condition.
5. Turn the regulator knob clockwise to close the regulator.
6. Unscrew the regulator from the calibration cylinder.
7. Remove the calibration cup from the GasWatch 3.
8. Store the calibration kit in a safe and convenient place.
9. Press and release POWER/MODE to return to the **GAS.TEST** item in Maintenance Mode.
10. See "Entering Measuring Mode (START)" on page 85 to enter Measuring Mode.

---

## Sensor/Battery Replacement Date (SEN.DATE)

The **SEN.DATE** item allows you to keep track of when the sensor and the battery were replaced.

1. While in Maintenance Mode, press AIR to scroll to **SEN.DATE**.

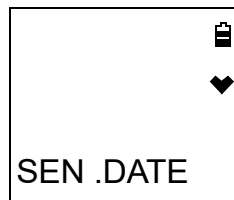

2. Press and release POWER/MODE. The sensor replacement date displays.

- Use AIR to scroll to the item whose replacement date you want to view or change.

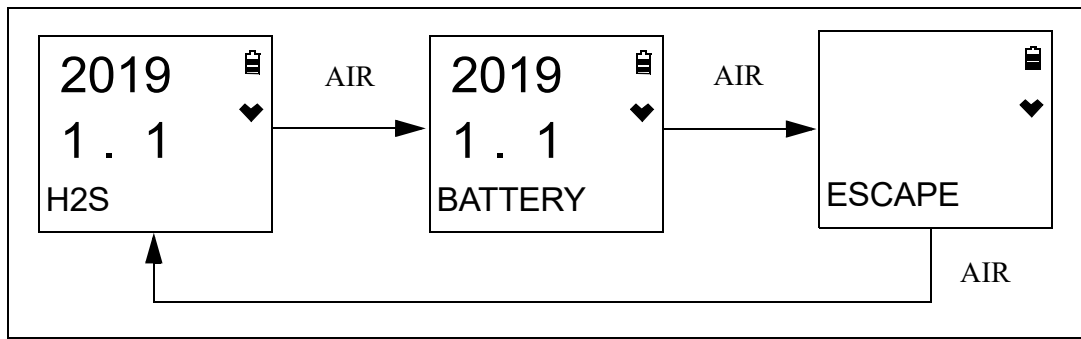

- To change the replacement date:
  - With the desired item displayed, press and release POWER/MODE.
  - Press and release POWER/MODE again to set the replacement date to the current date.
- Use the AIR button to scroll to **ESCAPE**.
- Press and release POWER/MODE to return to the **SEN.DATE** item in Maintenance Mode.
- See “Entering Measuring Mode (START)” on page 85 to enter Measuring Mode.

---

## Performing a Bump Test (BUMP)

See “Performing a Bump Test (BUMP)” on page 38 for a description of the **BUMP** item.

---

## Setting Alarms to Latching or Self-Resetting (LATCH)

**ON** (factory setting): The GasWatch 3 remains in alarm until the alarm condition passes *and* POWER/MODE is pressed.

**OFF**: The GasWatch 3 automatically resets an alarm when the alarm condition passes.

- While in Maintenance Mode, press AIR to scroll to **LATCH**.



- Press and release POWER/MODE. The current setting flashes.
- Use AIR to display the desired setting.
- Press and release POWER/MODE to save the setting and return to the **LATCH** item in Maintenance Mode.
- See “Entering Measuring Mode (START)” on page 85 to enter Measuring Mode.



---

## Turning the Demand Zero Function On/Off (D.ZERO)

**ON (factory setting):** You can manually perform a fresh air adjust in Measuring Mode by pressing AIR.

**OFF:** You cannot manually perform a fresh air adjust in Measuring Mode.

1. While in Maintenance Mode, press AIR to scroll to **D.ZERO**.

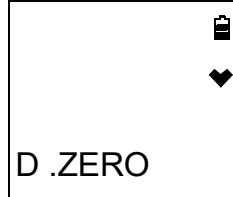

2. Press and release POWER/MODE. The current setting flashes.
3. Use AIR to display the desired setting.
4. Press and release POWER/MODE to save the setting and return to the **D.ZERO** item in Maintenance Mode.
5. See “Entering Measuring Mode (START)” on page 85 to enter Measuring Mode.

---

## Turning the Auto Zero Function On/Off (A.ZERO)

**ON:** The GasWatch 3 asks if you want to perform a fresh air adjustment at the end of the startup sequence.

**OFF (factory setting):** The GasWatch 3 does not ask if you want to perform a fresh air adjustment at the end of the startup sequence.

1. While in Maintenance Mode, press AIR to scroll to **A.ZERO**.

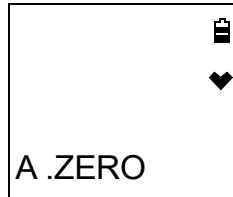

2. Press and release POWER/MODE. The current setting flashes.
3. Use AIR to display the desired setting.
4. Press and release POWER/MODE to save the setting and return to the **A.ZERO** item in Maintenance Mode.
5. See “Entering Measuring Mode (START)” on page 85 to enter Measuring Mode.

---

## Turning the ID Display Function On/Off (ID DISP)

**ON:** The User ID and Station ID screens appear in the startup sequence. If **DISP.SET** in User Mode is also set to **ON**, then the IDs can be changed in Display Mode.

**OFF (factory setting):** The User ID and Station ID screens do not appear in the startup sequence and the IDs cannot be changed in Display Mode.

1. While in Maintenance Mode, press AIR to scroll to **ID DISP**.

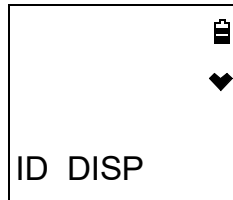

2. Press and release POWER/MODE. The current setting flashes.
3. Use AIR to display the desired setting.
4. Press and release POWER/MODE to save the setting and return to the **ID DISP** item in Maintenance Mode.
5. See “Entering Measuring Mode (START)” on page 85 to enter Measuring Mode.

---

## Turning the Zero Suppression On/Off (ZERO.SUP)

The **ZERO.SUP** setting is not intended for field adjustment. The default setting is **ON**. The suppression value is 2 ppm.

---

## Turning the Zero Follower On/Off (ZERO.FLW)

The **ZERO.FLW** setting is not intended for field adjustment. The default setting is **ON**.

---

## User Mode Zero Suppression (ZSUP.DSP)

**ON:** Zero suppression item appears in User Mode.

**OFF (factory setting):** Zero suppression item does not appear in User Mode. The zero suppression item is always available in Maintenance Mode.

It is not normally necessary to have the zero suppression item appear in User Mode. Contact RKI Instruments before turning this setting on.

---

## User Mode Zero Follower (ZFLW.DSP)

**ON:** Zero follower item appears in User Mode.

**OFF (factory setting):** Zero follower item does not appear in User Mode. The zero follower item is always available in Maintenance Mode.

It is not normally necessary to have the zero follower item appear in User Mode. Contact RKI Instruments before turning this setting on.

---

## Cylinder Setting (CYL.DISP)

**ON:** CYL SEL item appears in User and Maintenance Modes' GAS CAL item.

**OFF (factory setting):** CYL SEL item does not appear in User and Maintenance Modes' GAS CAL item.

This setting is only useful for multi-gas units. RKI Instruments, Inc. does not recommend adjusting this setting.

---

## Setting the Date/Time (DATE)

1. From the main menu, place the cursor next to **DATE**.

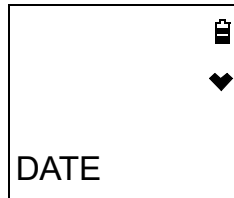

2. Press and release POWER/MODE. The date and time display with the year flashing.

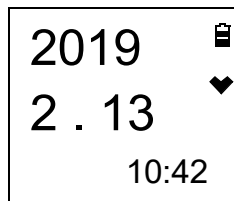

3. Use AIR to display the desired year.
  4. Press and release POWER/MODE to save the setting. The month setting flashes.
  5. Repeat Step 3 and Step 4 to enter the month, day, hours, and minutes settings. The date and time are saved and the instrument returns to the **DATE** item in Maintenance Mode.
  6. See "Entering Measuring Mode (START)" on page 85 to enter Measuring Mode.
- 

## Turning the Password On/Off (PASS-W)

**ON (factory setting):** The GasWatch 3 prompts you for a password when you enter Maintenance Mode. The factory-set password is **3000** but it can be changed.

**OFF:** No password is required to enter Maintenance Mode.

1. While in Maintenance Mode, press AIR to scroll to **PASS-W**.

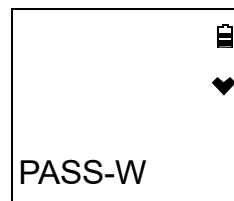

2. Press and release POWER/MODE. The current setting flashes.
3. Use AIR to display the desired setting.

4. If you selected **OFF**, press and release POWER/MODE to save the setting and return to the **PASS-W** item in User Mode.

If you selected **ON**, continue with Step 5.

5. Press and release POWER/MODE. The Set Password Screen appears. The current password displays and the first digit flashes.

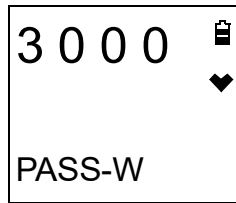

6. Use AIR to display a number from 0 to 9.
7. Press and release POWER/MODE to enter the selection and advance to the next number. To go back a number, press and hold AIR and POWER/MODE for a few seconds.
8. Repeat Step 6 and Step 7 to select the remaining numbers. When you press and release POWER/MODE to enter the last number, the password is saved and the instrument returns to the **PASSWORD** item in Maintenance Mode.
9. See “Entering Measuring Mode (START)” on page 85 to enter Measuring Mode.

---

## Viewing the ROM/SUM (ROM/SUM)

The **ROM/SUM** screen shows the instrument’s firmware version and firmware checksum.

1. While in Maintenance Mode, press AIR to scroll to **ROM/SUM**.

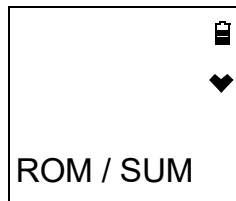

2. Press and release POWER/MODE. The screen cycles through the main board’s ROM/SUM and the sensor board’s ROM/SUM. The ROM is the top value and the SUM is the bottom value.

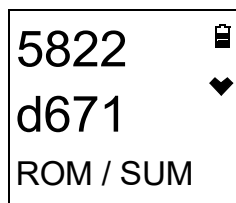

3. Press and release POWER/MODE to return to the **ROM/SUM** item in Maintenance Mode.
4. See “Entering Measuring Mode (START)” on page 85 to enter Measuring Mode.

---

## Performing a Default (M.DEF)

Performing a default operation in Maintenance Mode returns all parameters to their RKI factory settings.

1. While in Maintenance Mode, press AIR to scroll to **M.DEF**.



2. Press and release POWER/MODE.

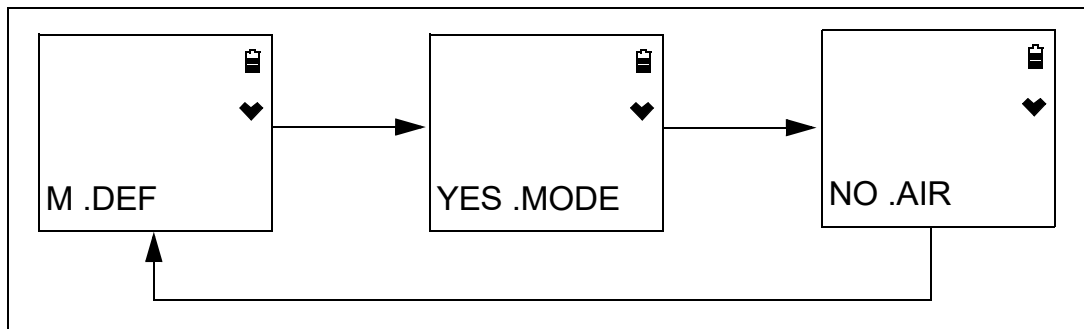

3. Press and release POWER/MODE to perform a default operation. The instrument asks if you are sure you want to perform a default operation.

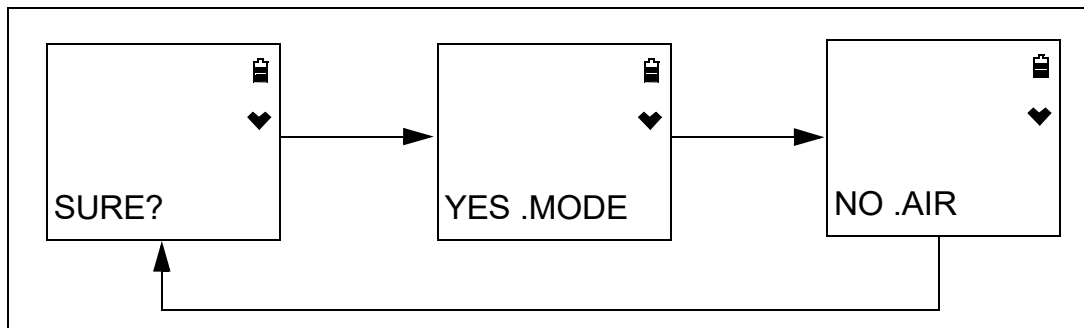

4. Press and release POWER/MODE to perform a default operation. The instrument beeps twice and returns to the **M.DEF** item in Maintenance Mode.
5. See “Entering Measuring Mode (START)” on page 85 to enter Measuring Mode.

---

## Entering Measuring Mode (START)

1. While in Maintenance Mode, press AIR to scroll to **START**.



2. Press and release POWER/MODE. The instrument begins its warmup sequence.

## Appendix B: Gas Select Mode

### Overview

This appendix describes the GasWatch 3 in Gas Select Mode. The GasWatch 3 is factory-set to suit most applications. Update settings in Gas Select Mode only if required for your specific application. A description of the Gas Select Mode items is shown in Table 12 below.

**Table 12: Gas Select Mode Menu Items**

Menu Item (Page # of Description)	Description
SAVE-AP (pg.87)	Set the current alarm points as the default alarm points.
MAX SPAN (pg.88)	<b>ON</b> : Maximum span screen appears after a successful calibration. <b>OFF (factory setting)</b> : No maximum span screen appears.
STEALTH (pg.89)	<b>STEALTH ON</b> : No backlight, LED, or buzzer operation. <b>STEALTH OFF (factory setting)</b> : Backlight, LED, and buzzer operate normally. <i>This setting has no effect unless <b>STEALTH</b> is set to <b>ON</b>.</i> <b>VIB ON</b> : Vibrator activates for alarm conditions. <b>VIB OFF (factory setting)</b> : Vibrator does not activate in any situation.
START (pg.89)	Enter Measuring Mode

### Entering Gas Select Mode

**WARNING:** *The GasWatch 3 is not in operation as a gas detector while in Gas Select Mode.*

1. Take the GasWatch 3 to a non-hazardous location and turn it off if it is on.
2. Press and hold AIR, then press and hold POWER/MODE. You will hear a beep after one second. Continue to hold the buttons down.
3. You will hear a second beep. Continue to hold the buttons down.
4. When you hear a third beep, release the buttons.
5. A password screen appears and the first digit flashes. The password is **2014**.

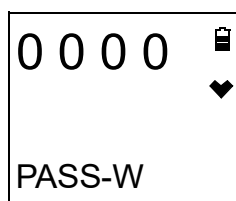

6. Use AIR to select each password number then press POWER/MODE to save it and move on to the next number. To go back a number, press and hold AIR and POWER/MODE for a few seconds.
7. The **SAVE-AP** item displays.

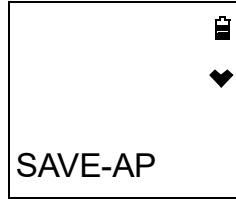

8. Use AIR to move through the Gas Select Mode items.

---

## Tips for Using Gas Select Mode

- To scroll from one item to the next, press and release AIR. To reverse the scrolling direction:
  - a. Press and hold AIR.
  - b. Immediately press POWER/MODE and then release both buttons.
  - c. The scrolling direction returns to the original direction when you exit and reenter a menu.
- To skip an item when a question is asked, press and release AIR.
- To enter an item and to save any changes, press and release POWER/MODE.
- To change a flashing parameter, press and release AIR. To reverse the direction of change (ie. from increasing to decreasing or vice versa):
  - a. Press and hold AIR.
  - b. Immediately press POWER/MODE and then release both buttons.
- To exit an entered item without saving a change, press and hold AIR and POWER/MODE for a few seconds.

---

## Saving the Alarm Points (SAVE-AP)

Performing a **SAVE-AP** operation saves the current alarm setpoints.

Performing a **DEF.ALMP** operation in the **ALARM-P** User Mode menu sets the instrument's alarm points to those saved during the **SAVE-AP** operation (if performed).

Performing a **SAVE-AP** has no effect on an **M.DEF** in Maintenance Mode. An **M.DEF** operation returns all instrument settings to the RKI default regardless of if a **SAVE-AP** operation was performed.

1. While in Gas Select Mode, press AIR to scroll to **SAVE-AP**.

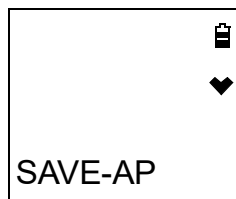

2. Press and release POWER/MODE. The display cycles through the following screens.

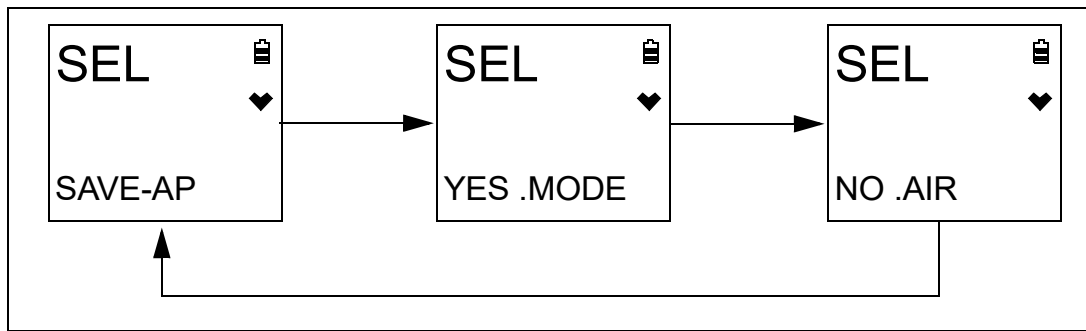

3. Press and release POWER/MODE to save the current alarm point settings as the default.
4. The instrument returns to the **SAVE-AP** item in Gas Select Mode.
5. See “Exiting Gas Select Mode (START)” on page 89 to enter Measuring Mode.

---

## Turning Calibration Max Span On/Off (MAX.SPAN)

**ON:** After a passed calibration, the GasWatch 3 displays the response reading’s maximum adjustment. A maximum span of 50 ppm indicates that the reading could have been adjusted up to 50 ppm. If the maximum span value is close to the calibration value, the sensor should be replaced soon. The upper limit on the maximum adjustment indicated is either twice the calibration value or full scale, whichever is lower.

**OFF (factory setting):** There is no maximum span indication at the end of a calibration.

1. While in Gas Select Mode, press AIR to scroll to **MAX.SPAN**.

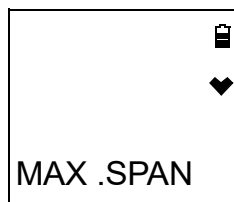

2. Press and release POWER/MODE. The current setting flashes.
3. Use AIR to display the desired setting.
4. Press and release POWER/MODE to save the setting and return to the **MAX.SPAN** item in Gas Select Mode.
5. See “Exiting Gas Select Mode (START)” on page 89 to enter Measuring Mode.



---

## Stealth and Vibrator Settings (STEALTH)

### STEALTH

#### ON:

- The instrument's backlight does not come on, regardless of the **BL TIME** setting.
- The instrument's LEDs do not come on for any reason, even alarm conditions.
- The instrument's buzzer does not sound for any reason, even alarm conditions.
- An "S" appears at the bottom of the LCD.

OFF (factory setting): The instrument's backlight, LEDs, and buzzer operate normally.

### VIB

The **VIB** setting only affects instrument operation if **STEALTH** is set to **ON**.

ON: The vibrator activates for alarm conditions. It can be useful to have this feature turned on if you have also turned **STEALTH** on.

OFF (factory setting): The vibrator does not activate for any reason.

1. While in Gas Select Mode, press AIR to scroll to **STEALTH**.



2. Press and release POWER/MODE. The current **STEALTH** setting flashes.
3. Use AIR to display the desired setting.
4. Press and release POWER/MODE. The current **VIB** setting flashes.
5. Use AIR to display the desired setting.
6. Press and release POWER/MODE to save the setting and return to the **STEALTH** item in Gas Select Mode.
7. See "Exiting Gas Select Mode (START)" on page 89 to enter Measuring Mode.

---

## Exiting Gas Select Mode (START)

1. While in Gas Select Mode, press AIR to scroll to **START**.



2. Press and release POWER/MODE. The instrument begins its warm-up sequence.

# Warranty

RKI Instruments, Inc. warrants the GasWatch 3 sold by us to be free from defects in materials, workmanship, and performance for a period of three years from the date of shipment from RKI Instruments, Inc. This includes the instrument and the original sensor. Replacement parts are warranted for 1 year from the date of their shipment from RKI Instruments, Inc. except for replacement sensors which are warranted for 3 years. Any parts found defective within their warranty period will be repaired or replaced, at our option, free of charge. This warranty does not apply to those items which by their nature are subject to deterioration or consumption in normal service, and which must be cleaned, repaired, or replaced on a routine basis. Examples of such items are:

Absorbent cartridges

Filter elements, disks, or sheets

Pump diaphragms and valves

Warranty is voided by abuse including mechanical damage, alteration, rough handling, or repair procedures not in accordance with the instruction manual. This warranty indicates the full extent of our liability, and we are not responsible for removal or replacement costs, local repair costs, transportation costs, or contingent expenses incurred without our prior approval.

THIS WARRANTY IS EXPRESSLY IN LIEU OF ANY AND ALL OTHER WARRANTIES AND REPRESENTATIONS, EXPRESSED OR IMPLIED, AND ALL OTHER OBLIGATIONS OR LIABILITIES ON THE PART OF RKI INSTRUMENTS, INC. INCLUDING BUT NOT LIMITED TO THE WARRANTY OF MERCHANTABILITY OR FITNESS FOR A PARTICULAR PURPOSE. IN NO EVENT SHALL RKI INSTRUMENTS, INC. BE LIABLE FOR INDIRECT, INCIDENTAL, OR CONSEQUENTIAL LOSS OR DAMAGE OF ANY KIND CONNECTED WITH THE USE OF ITS PRODUCTS OR FAILURE OF ITS PRODUCTS TO FUNCTION OR OPERATE PROPERLY.

This warranty covers instruments and parts sold to users only by authorized distributors, dealers, and representatives as appointed by RKI Instruments, Inc.

We do not assume indemnification for any accident or damage caused by the operation of this gas monitor and our warranty is limited to replacement of parts or our complete goods.